

Ese sapo se pesa

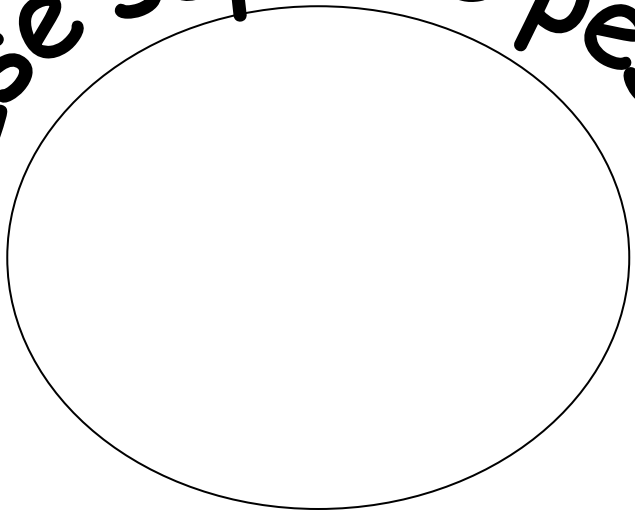

Mi nombre: _____

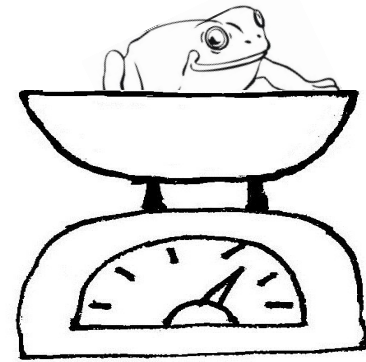

Ese _____ se pesa.

2

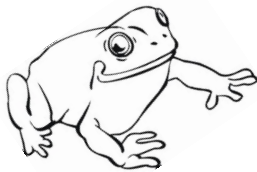

Ese sapo se llama _____.

1

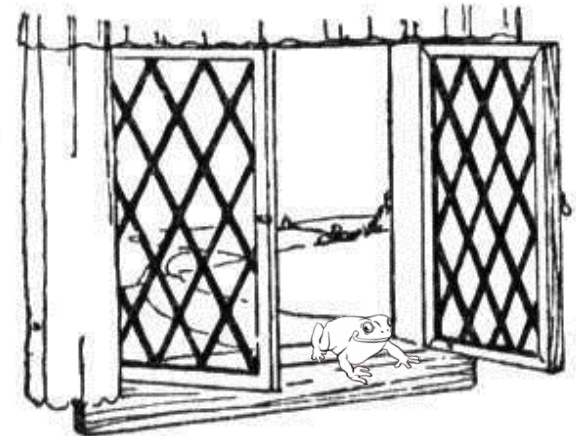

Ese sapo se _____.

3

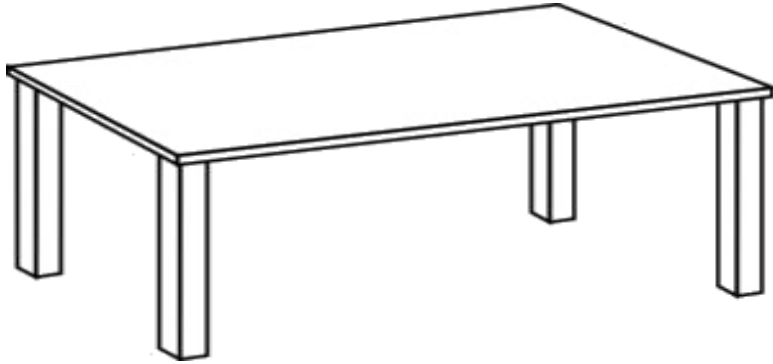

Pasa ese sapo a mi _____.

4

Banco de palabras

ese

se

sapo

ama

pasa

mesa

pesa

Pepe

6

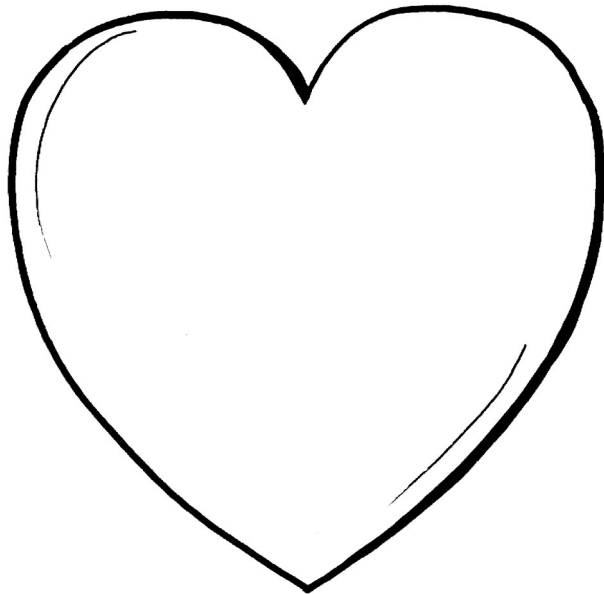
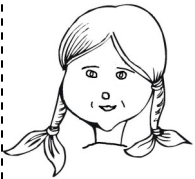

Susi ama a ese _____.

5

Pepe y Susi.

