

Dual Schools: Teach Dual-Dos Idiomas

My bilingual  
abc

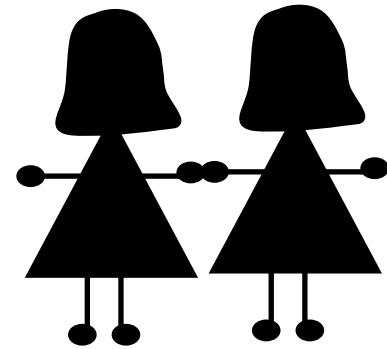

Mi abc bilingüe

Cognates **ABC** Congnados

A a

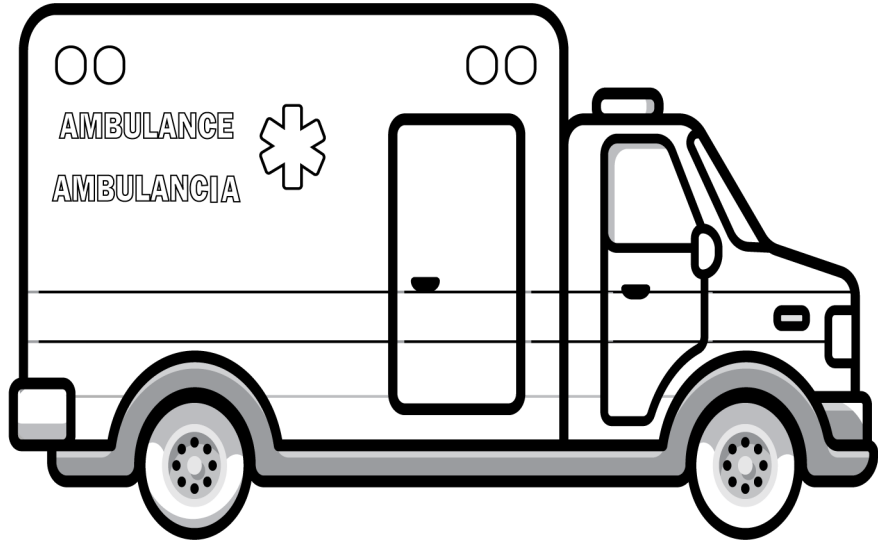

ambulancia

ambulance

A a

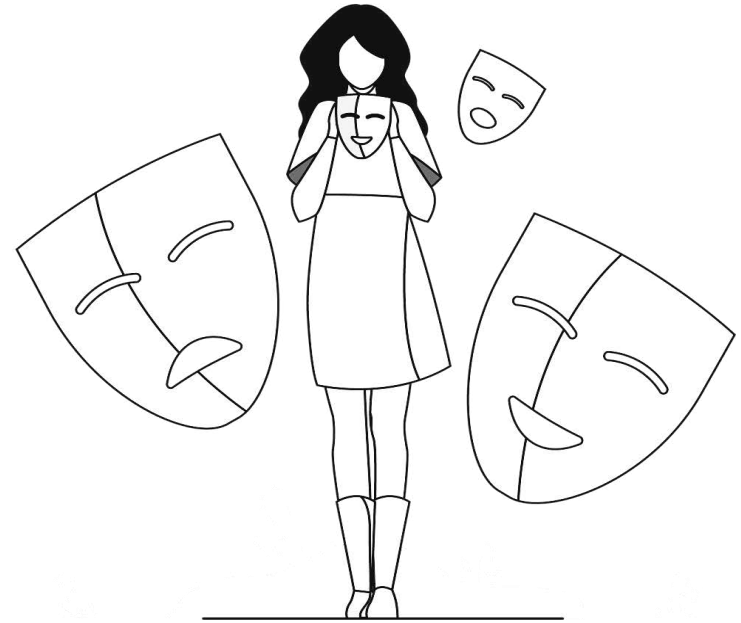

actress

actriz

Aa

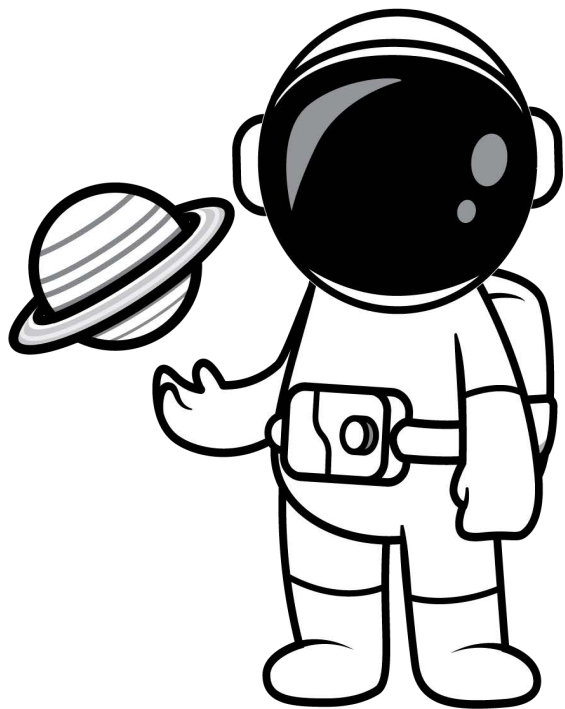

astronaut

astronauta

Aa



angel

angel

Bb

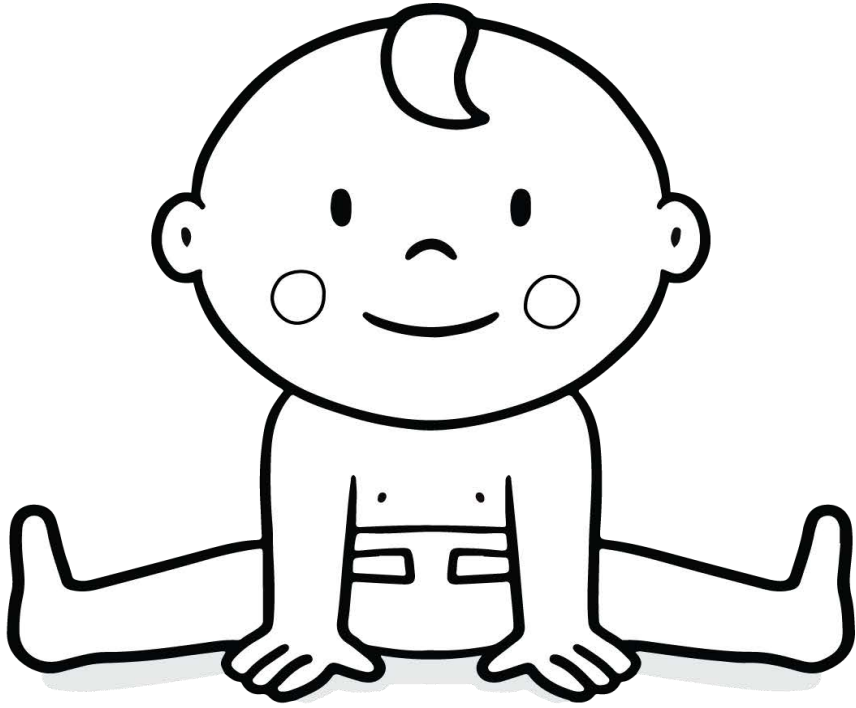

baby

babé

Bb



bat

bate

Bb



boots

botas

Bb

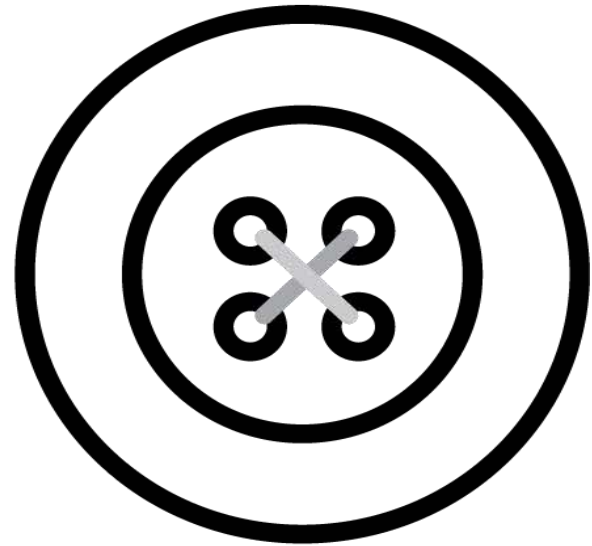

button

botón

Cc

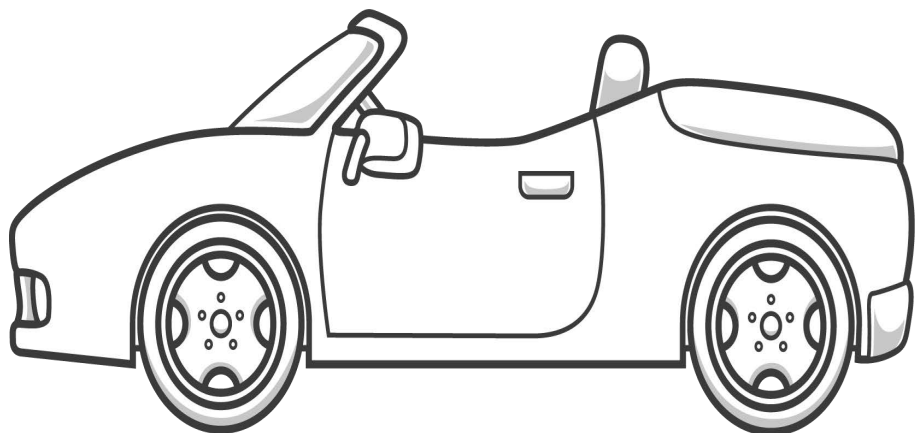

car

carro

Cc

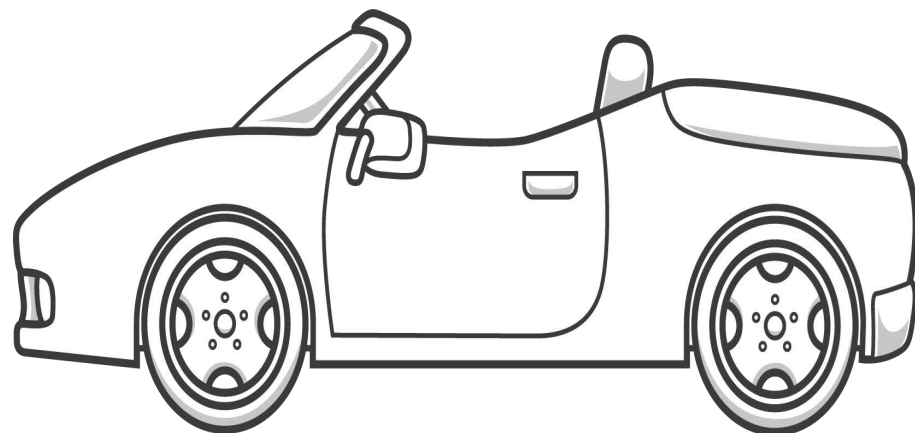

car

coche

Cc

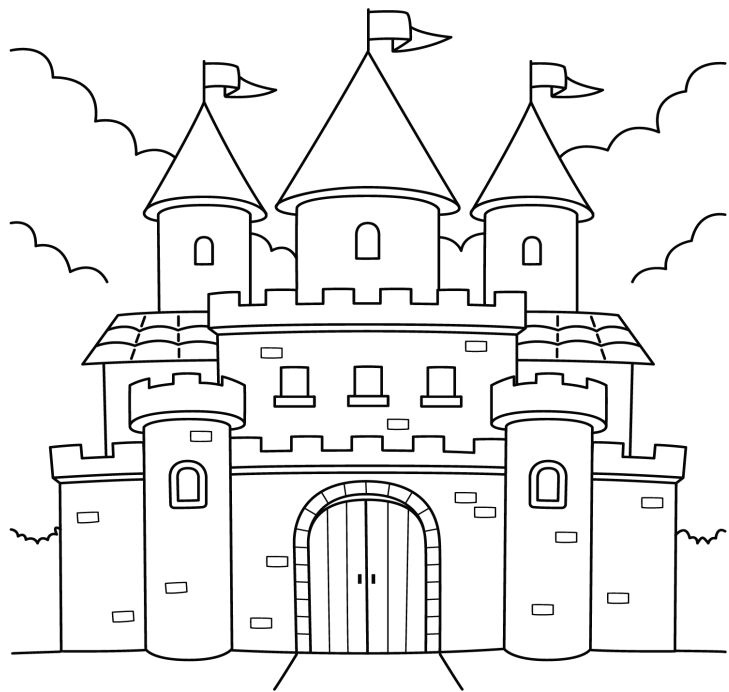

caste

castillo

Cc

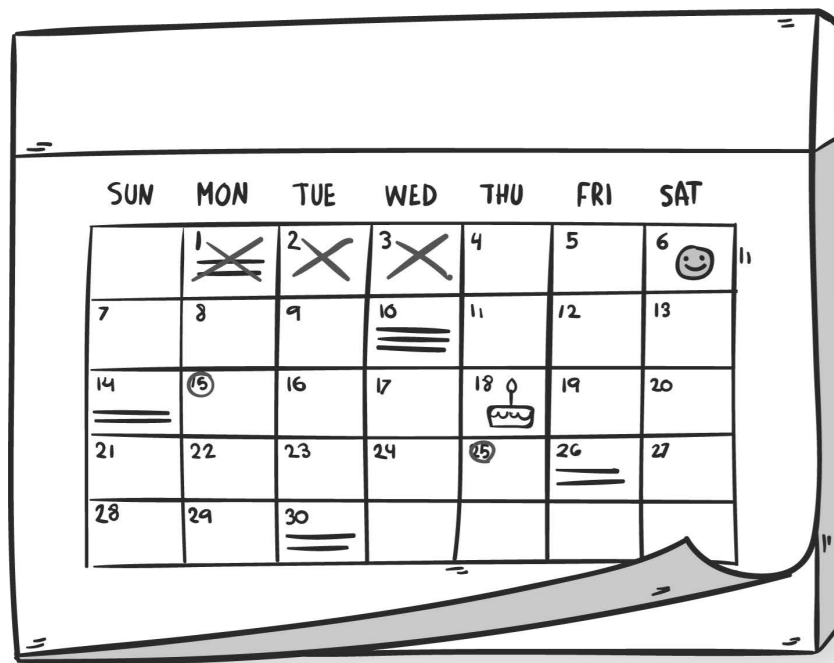

calendar

calendario

Cc

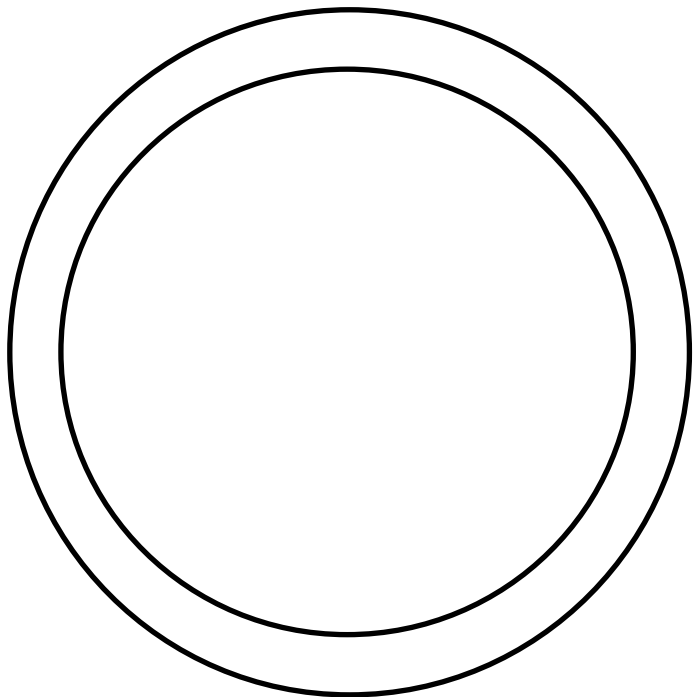

circle

círculo

Cc



cent

centavo



Cc

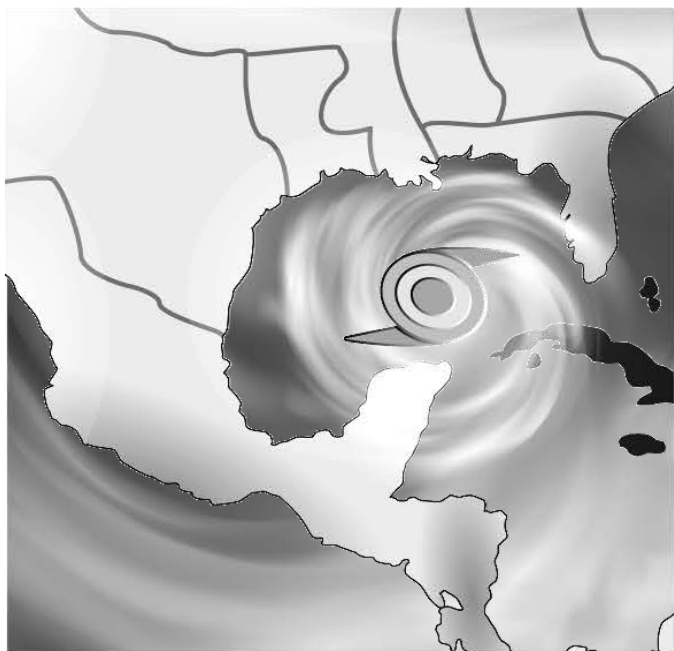

cyclone

ciclón

Cc



centaur

centauro

D d

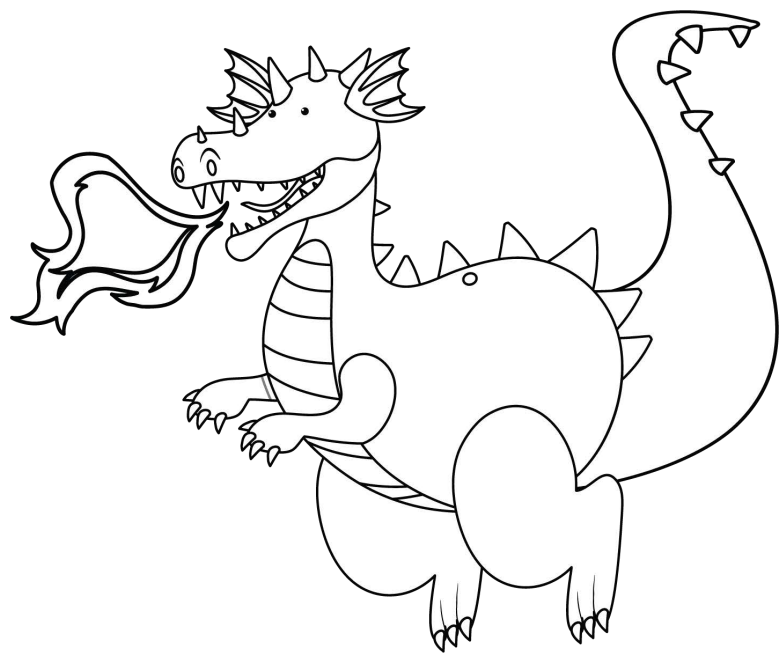

dragon

dragón

D d

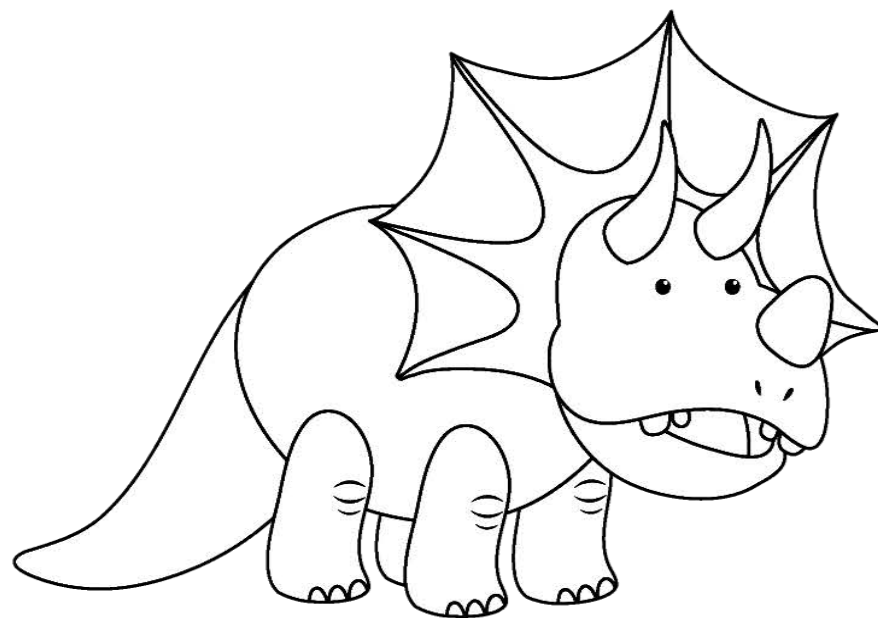

dinosaur

dinosaurio

D d

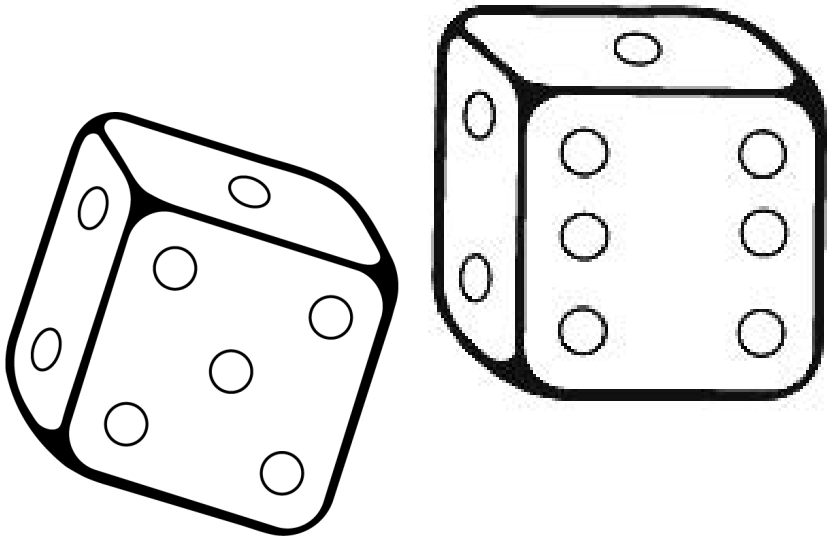

dice

dados

D d

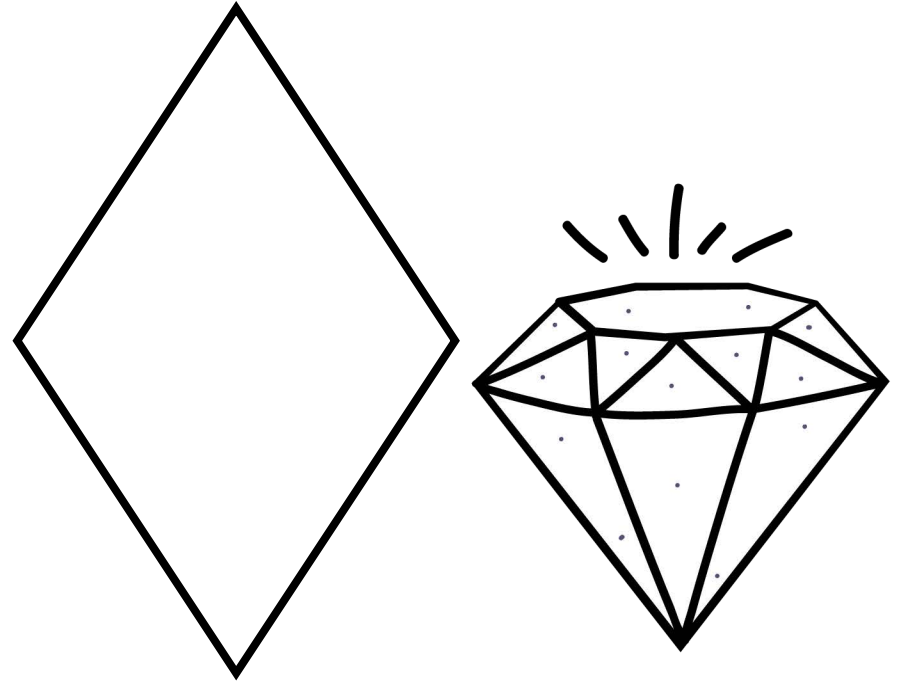

diamond

diamante

Ee

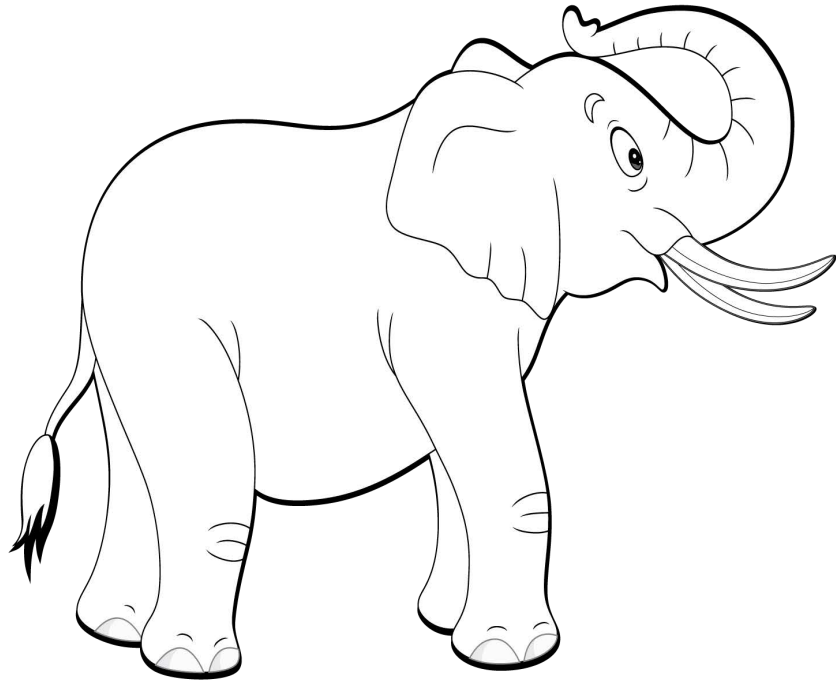

elephant

elefante

Ee

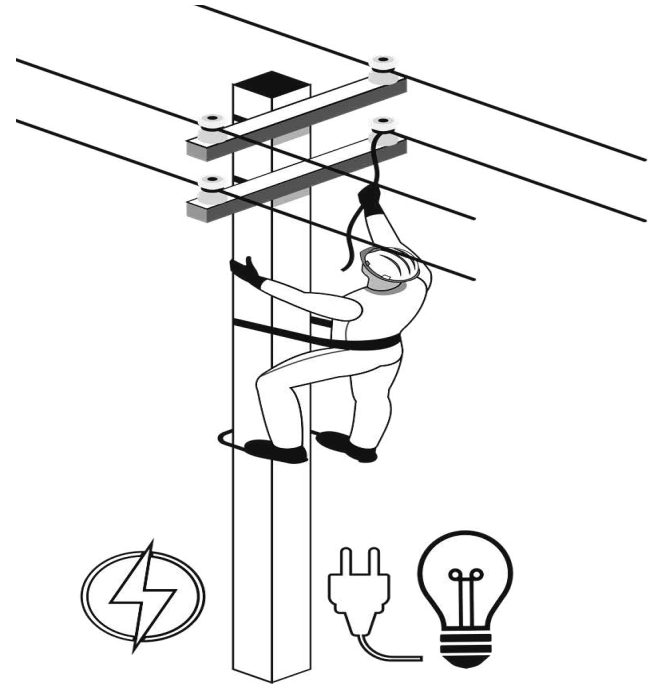

electricity

electricidad

Ee

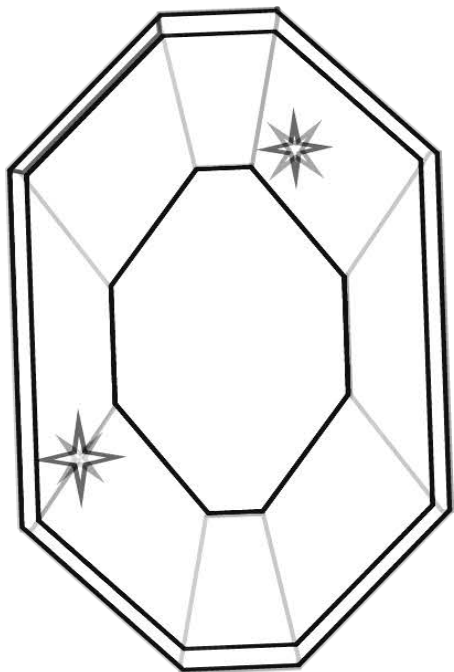

emerald

esmeralda

Ee



elf

elfo

Ff

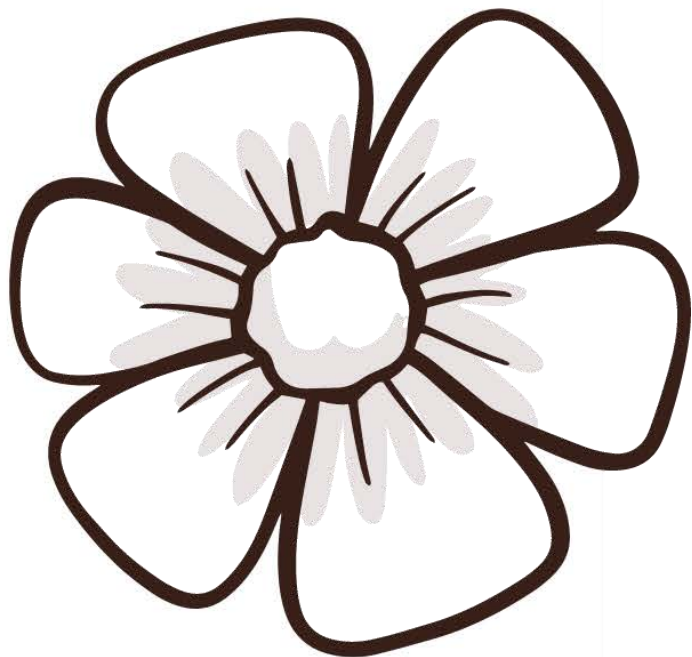

flower

flor

Ff

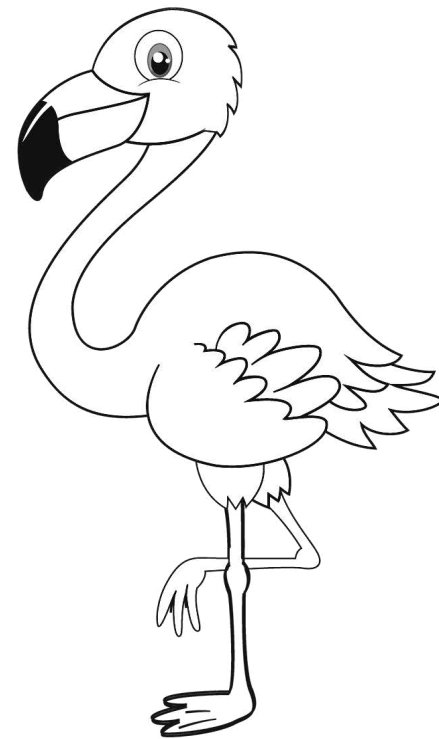

flamingo

flamenco

Ff



fire

fuego

Ff



fountain

fuentes

Gg

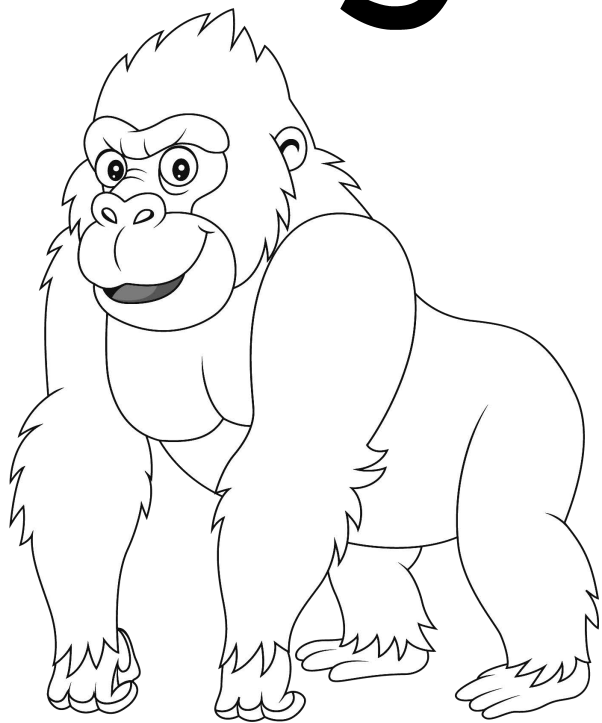

gorilla

gorilla

Gg



goose

goose



Gg

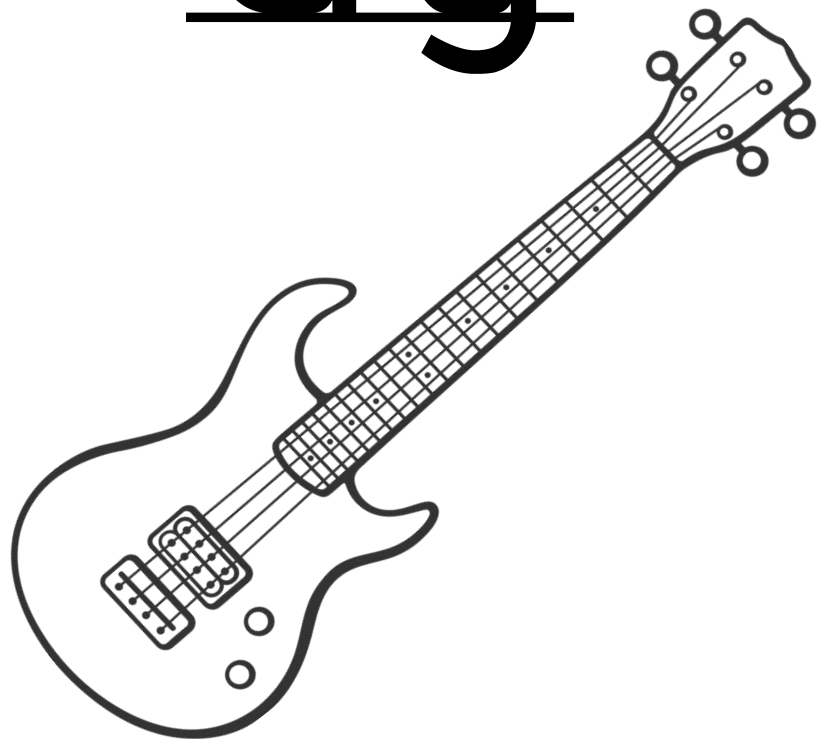

guitar

guitarra

Gg

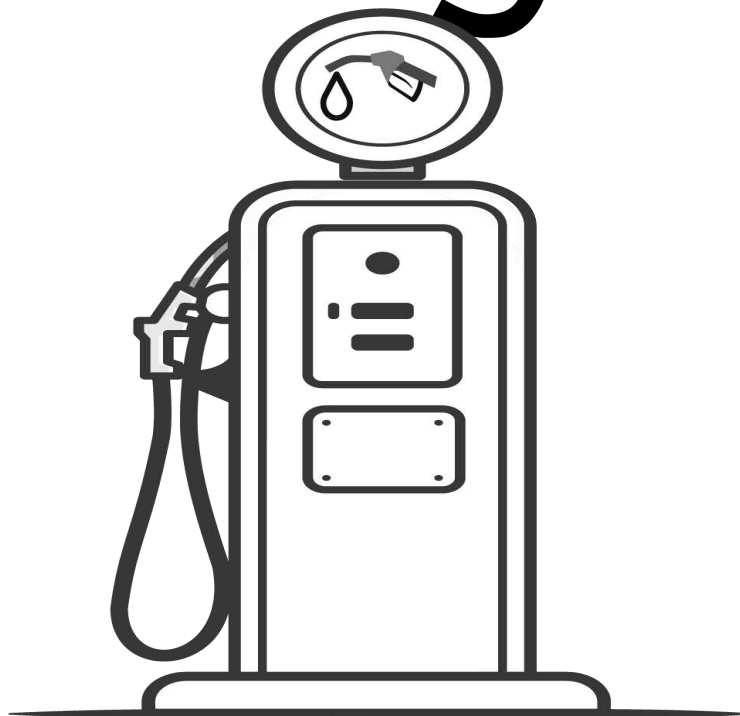

gasoline

gasolina

Hh

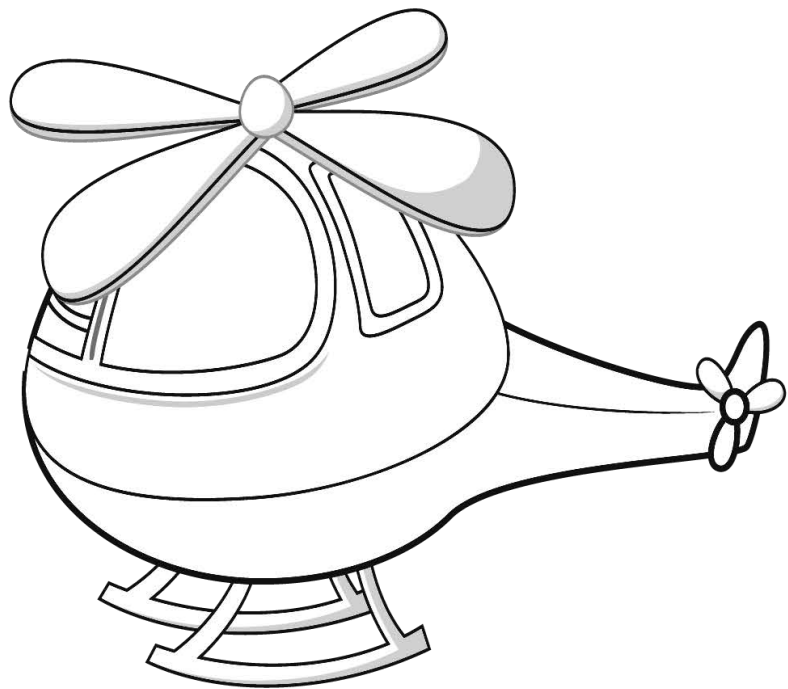

helicopter

helicóptero

Hh

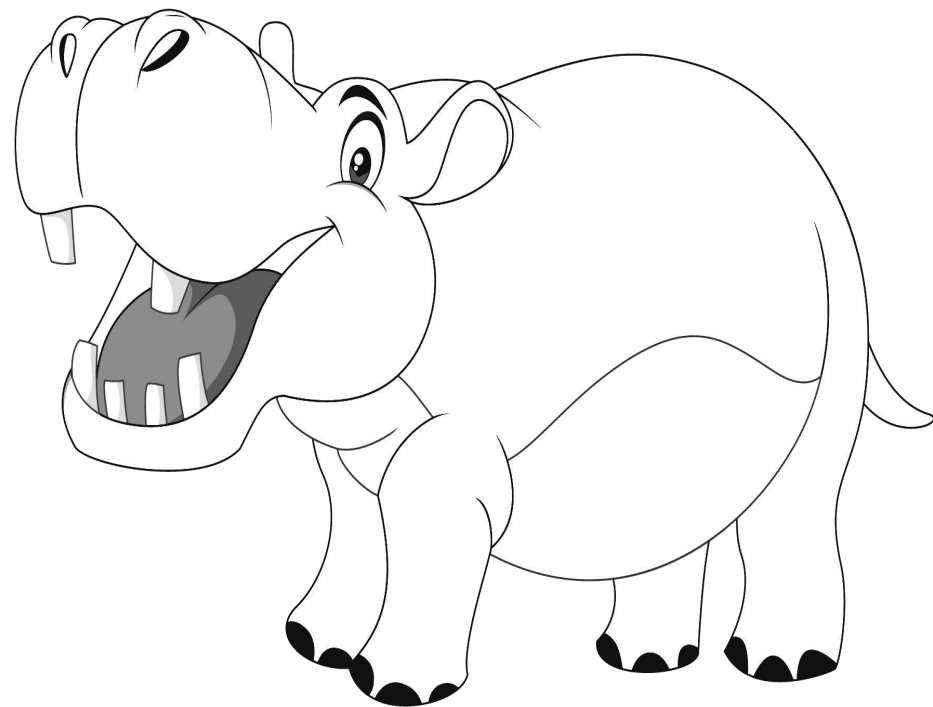

hippopotamus

hipopótamo

Hh

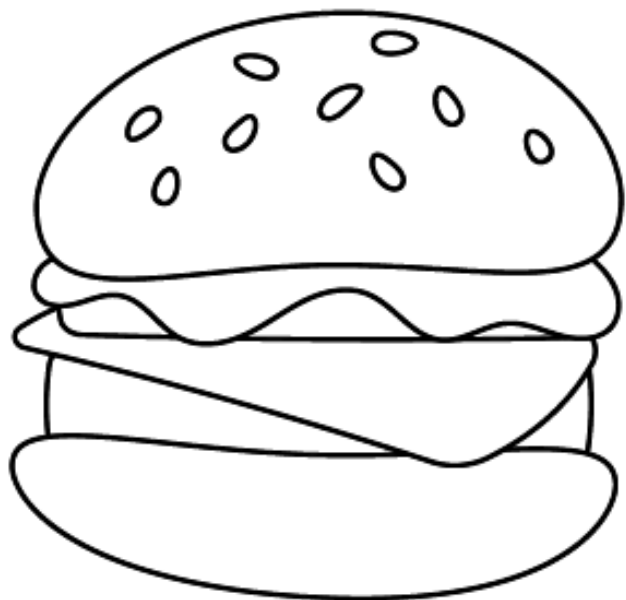

hamburger

hamburguesa

Hh

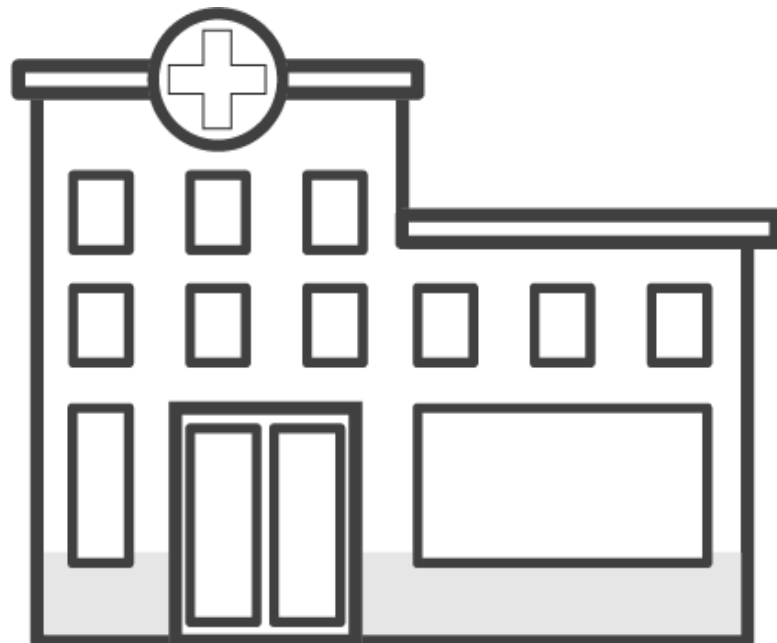

hospital

hospital

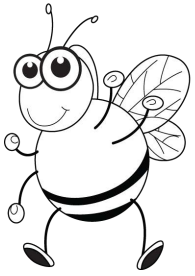

Ii

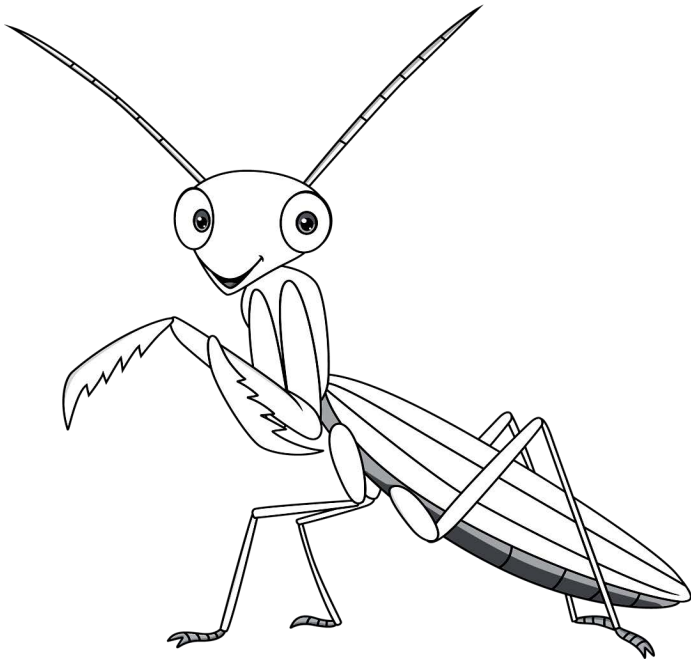
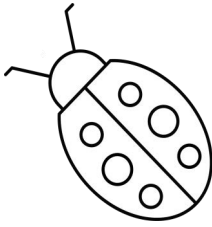

insect

insecto

Ii

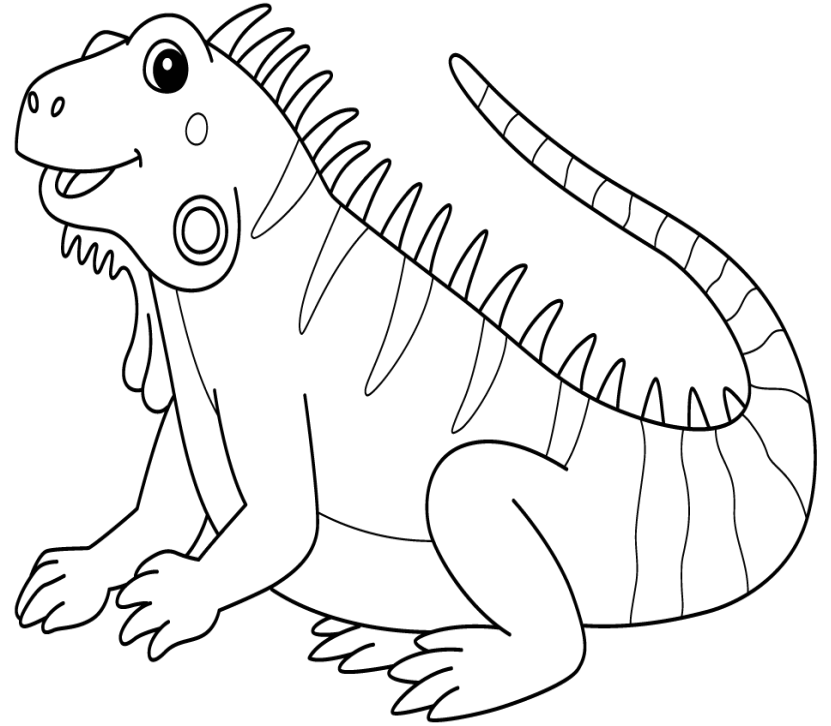

iguana

iguana

Ii

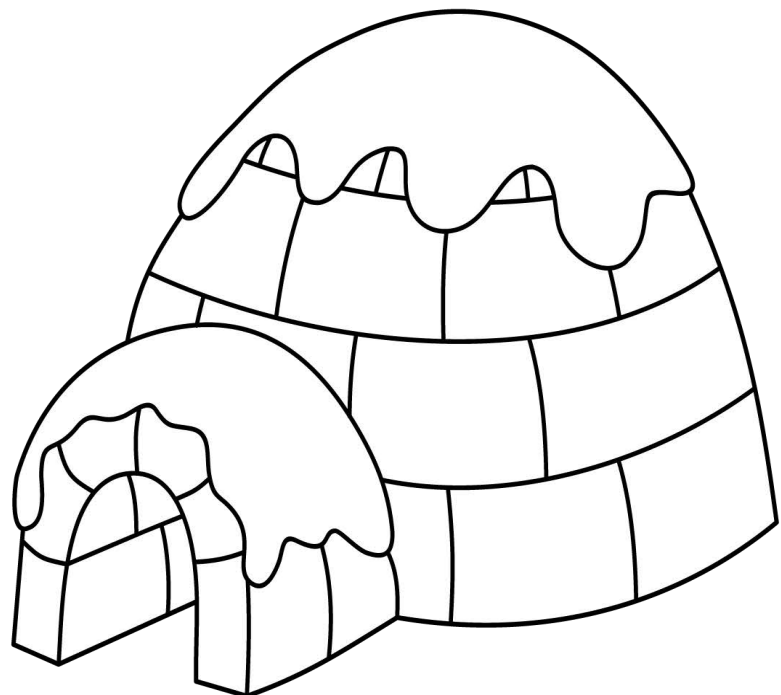

igloo

igloo

Ii

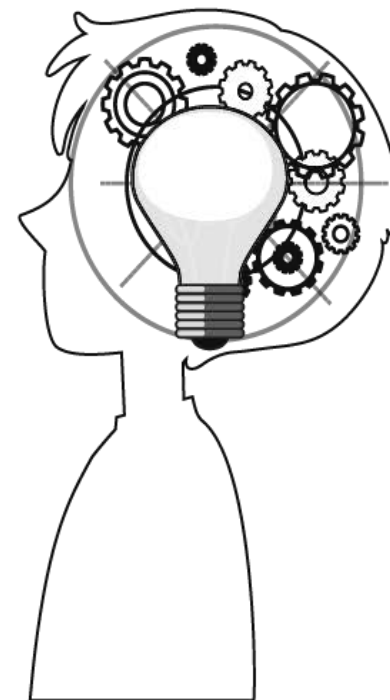

idea

idea

Jj

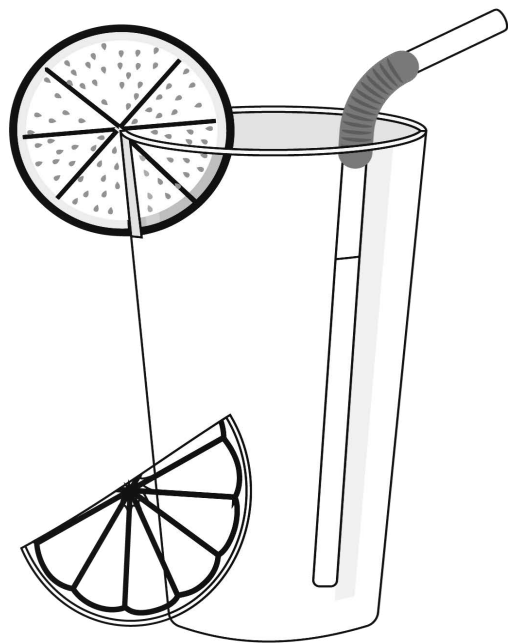

juice

juice

Jj



jug

jug

Jj

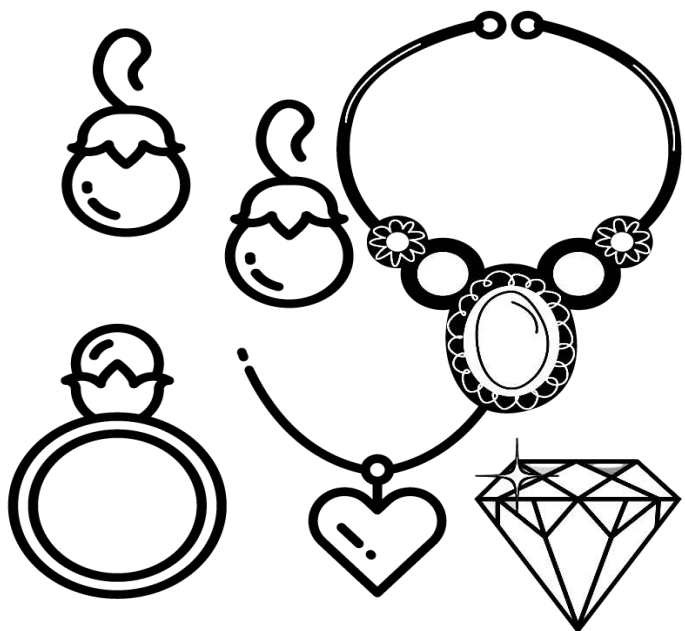

jewelry

joyas

Jj

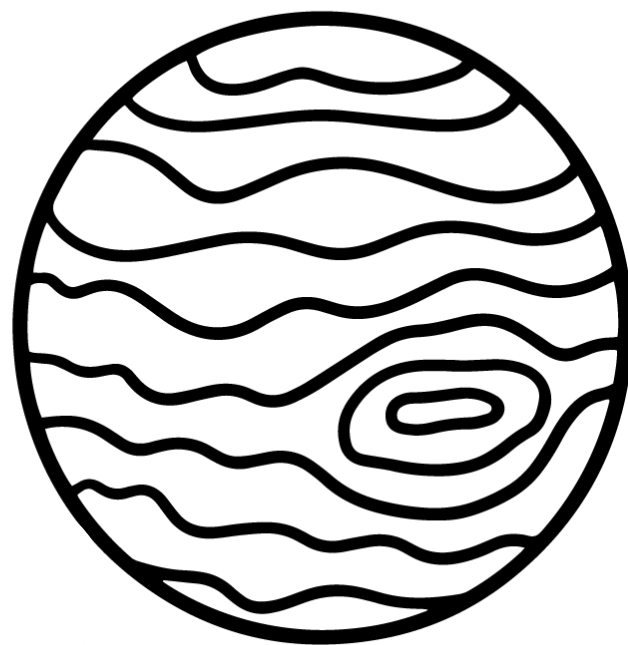

Jupiter

Júpiter

Kk

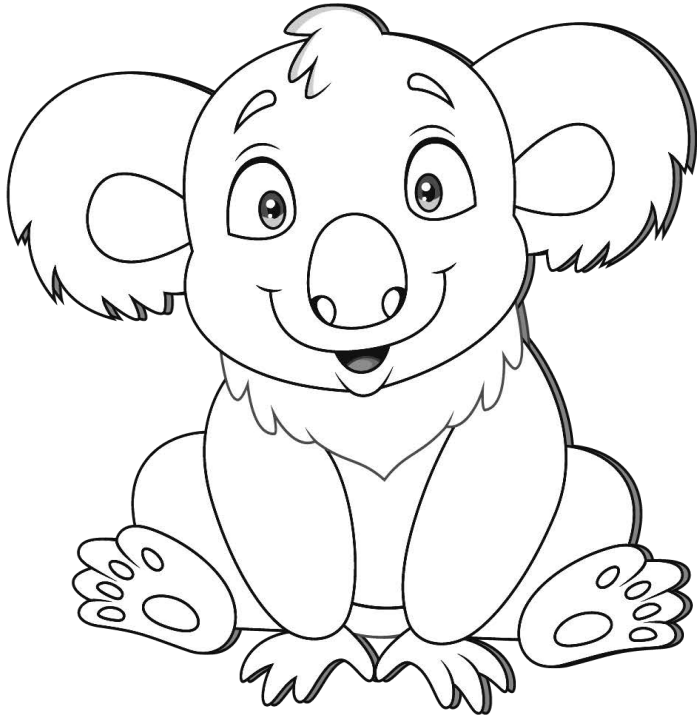

koala

koala

Kk

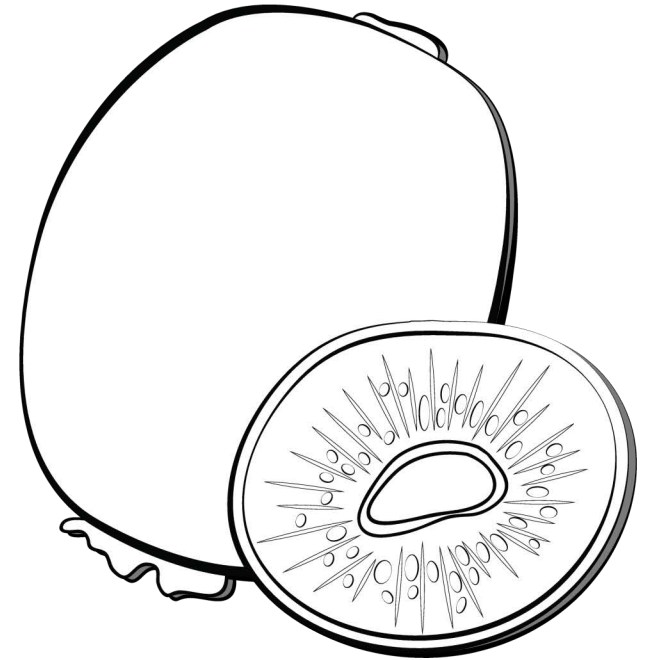

kiwi

kiwi



Kk

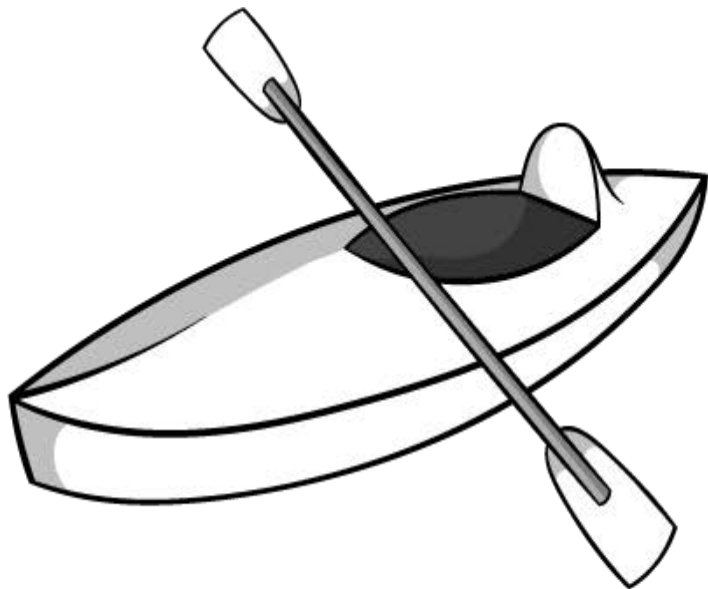

kayak

kayak

Kk



kilo

kilo

LI

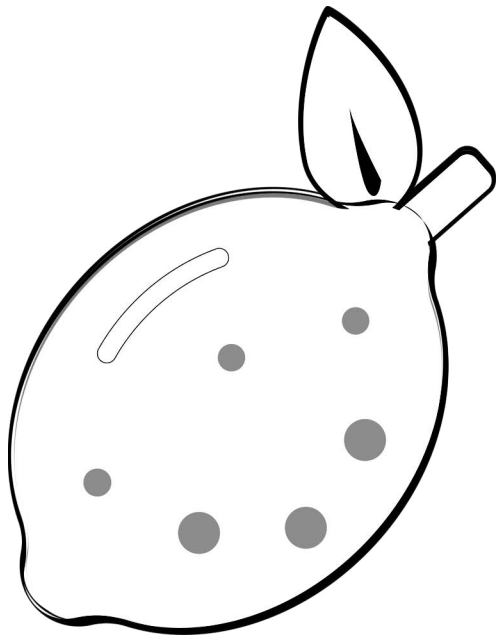

lemon

limón

LI

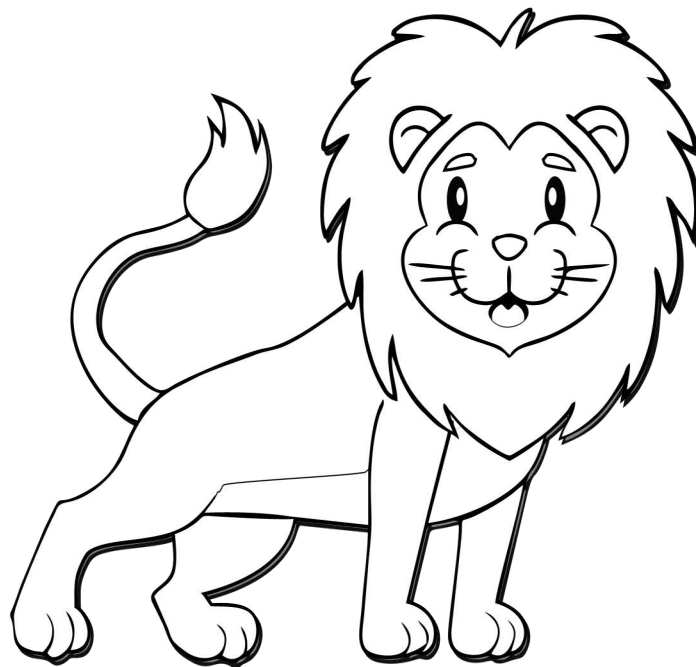

lion

león

Ll



lemonade

limonada

Ll



lake

lago

Mm

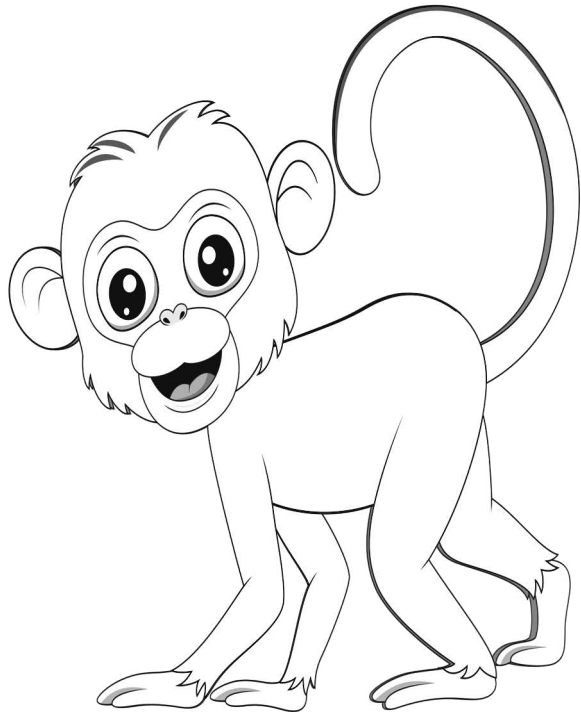

monkey

monno

Mm



mother

madre

Mm



mountains

montañas

Mm

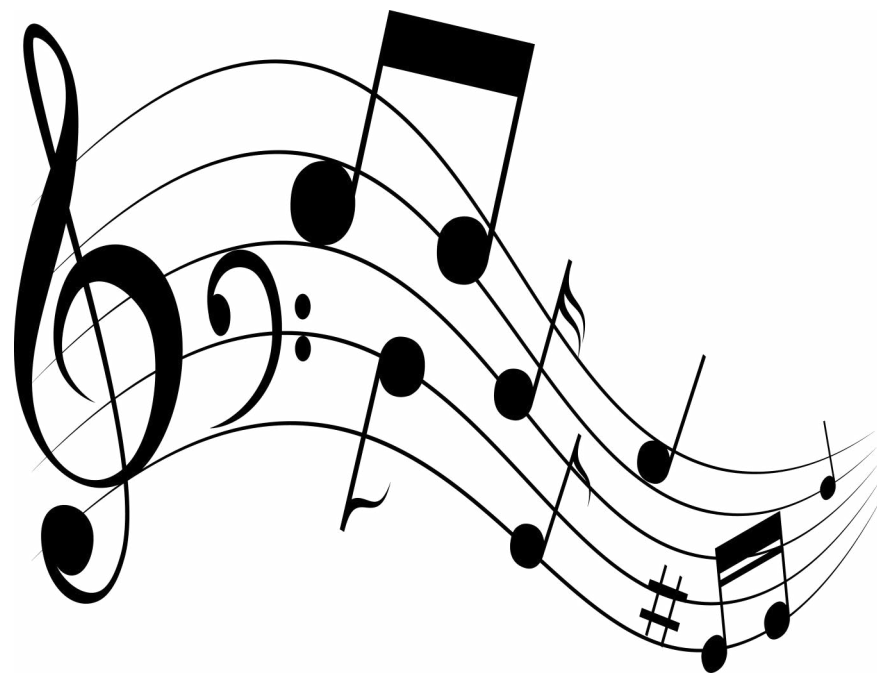

music

música

Nn

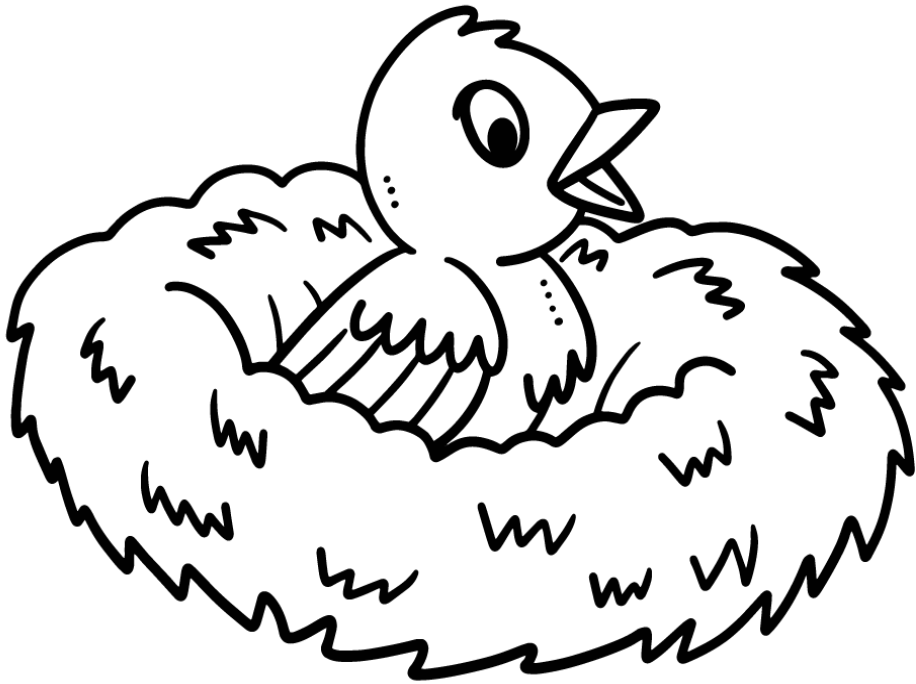

nest

nido

Nn

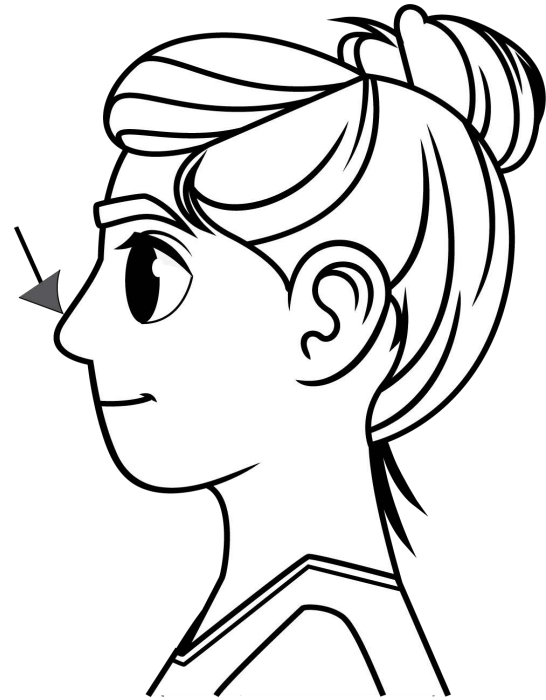

nose

nariz

Nn

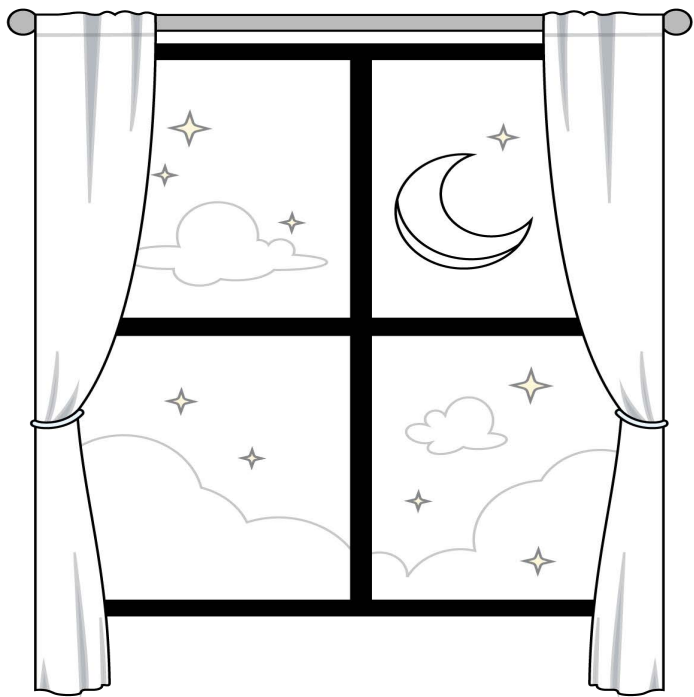

night

noche

Nn



note

nota

N ñ

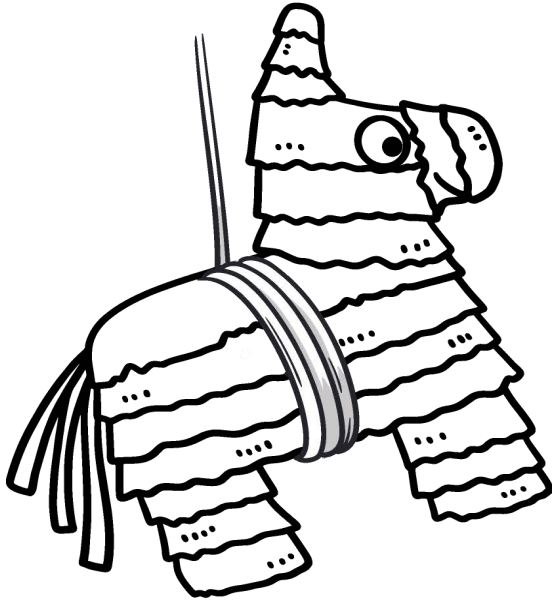

piñata

piñata

N ñ

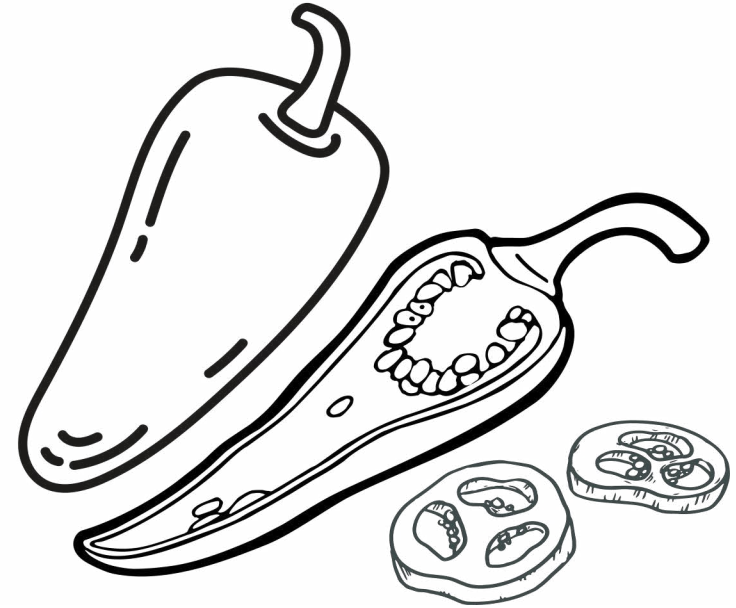

jalapeños

jalapeños



O o



ocean

océano

O o

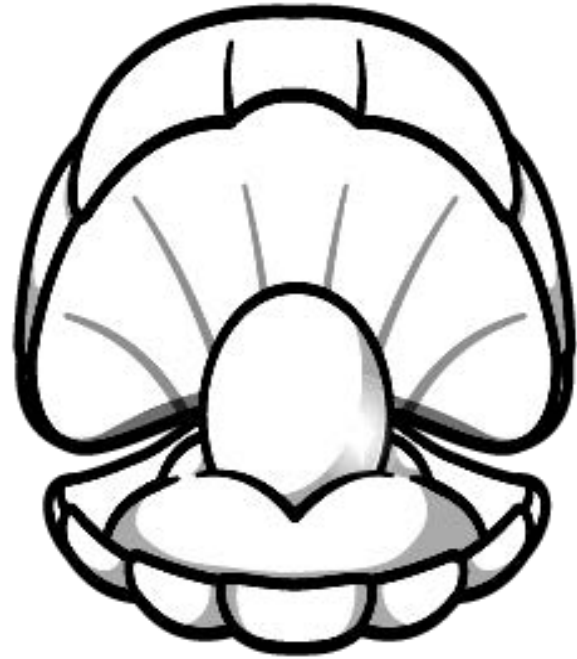

oyster

ostra

O o

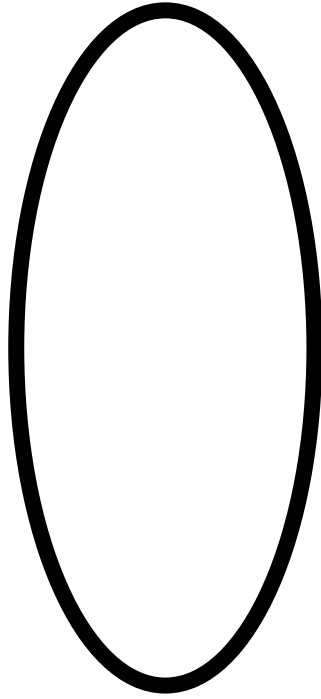

oval

óvalo

O o

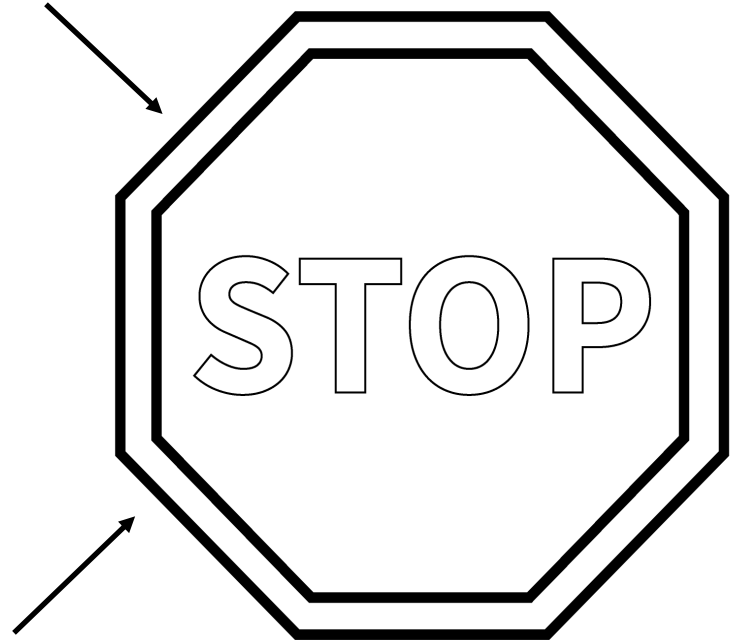

octagon

octógono

Pp

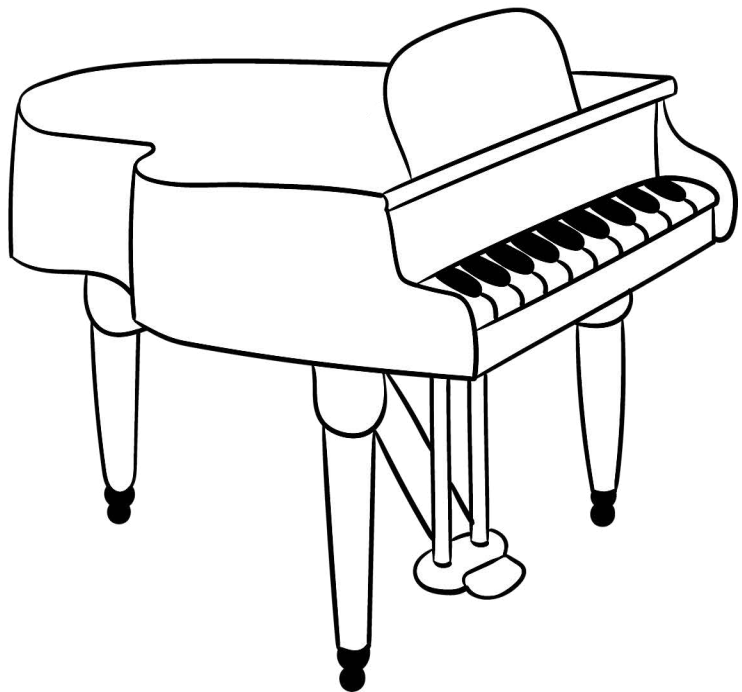

piano

piano

Pp

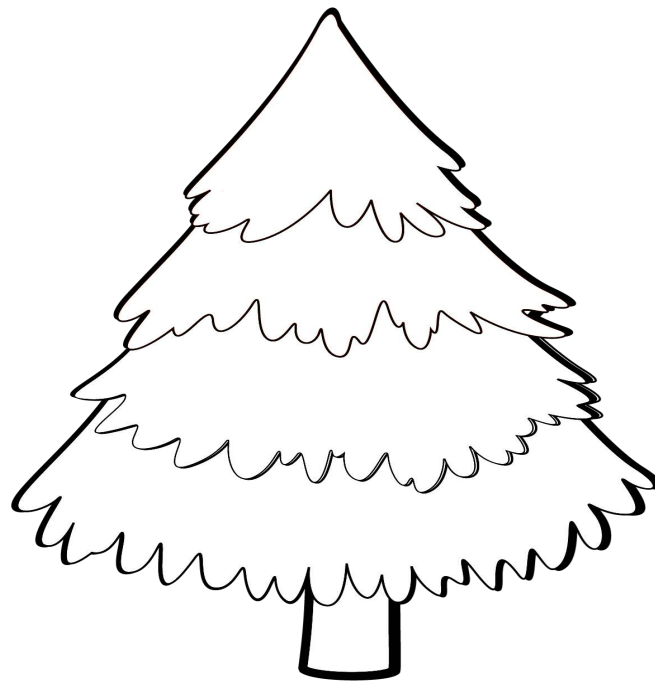

pine

pino

Pp

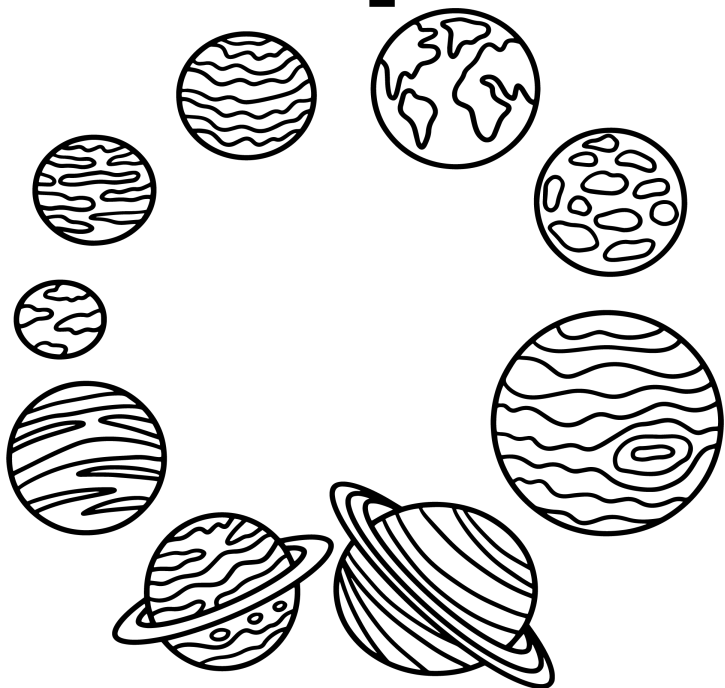

planets

planetas

Pp

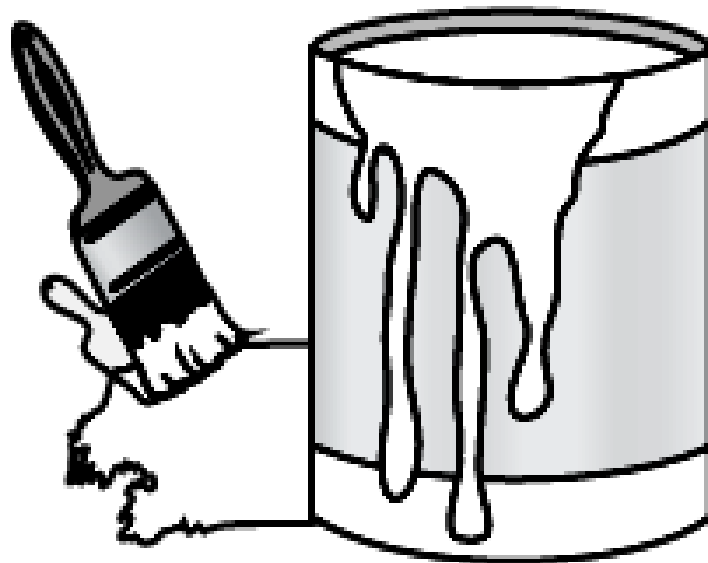

paint

pintura

Qq



quetzal

quetzal

Qq



quesadilla

quesadilla

Rr

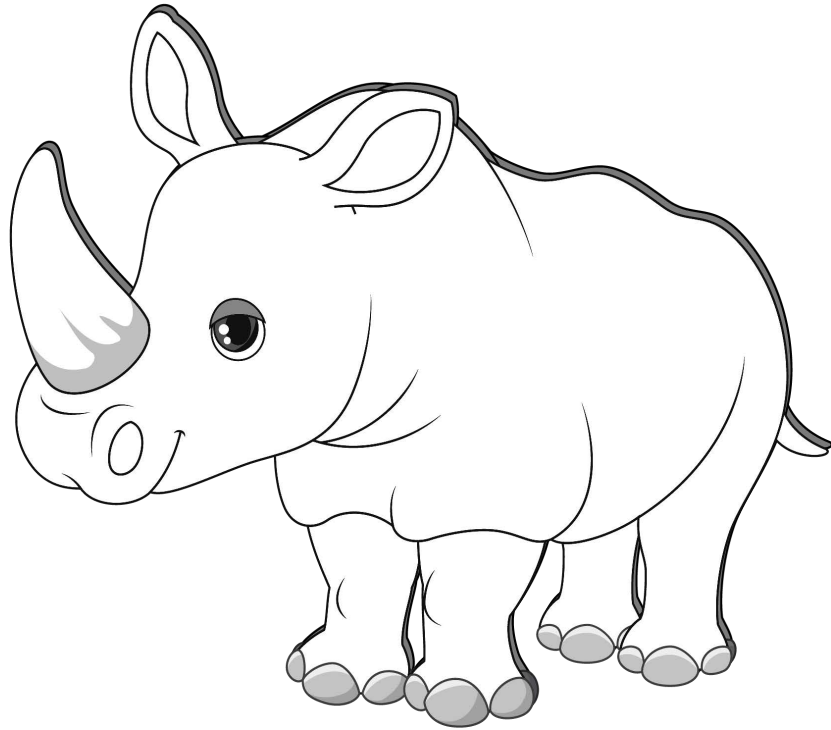

rhinoceros

rhinoceronte

Rr

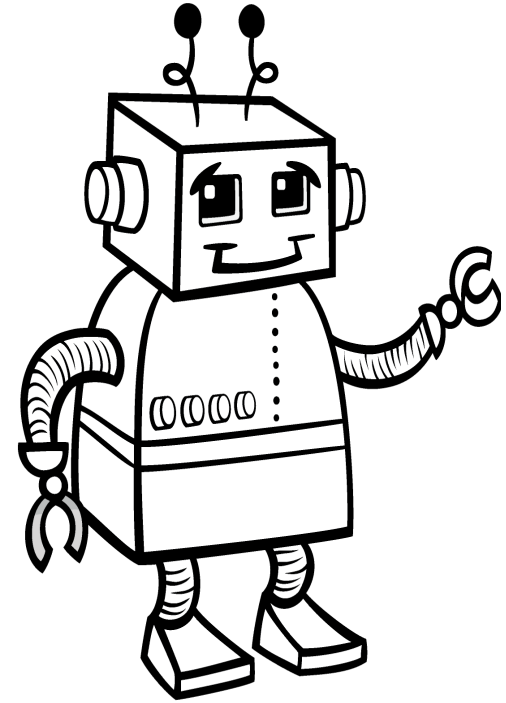

robot

robot

Rr

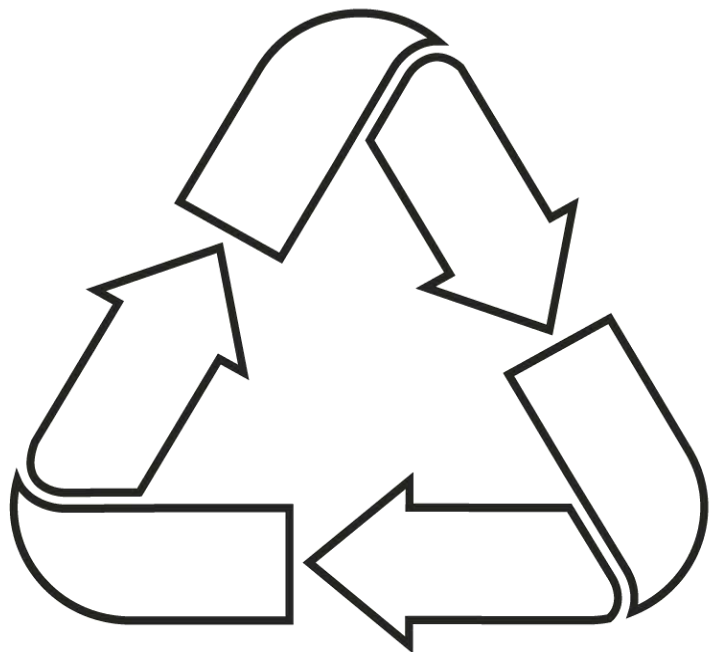

recycle

reciclar

Rr

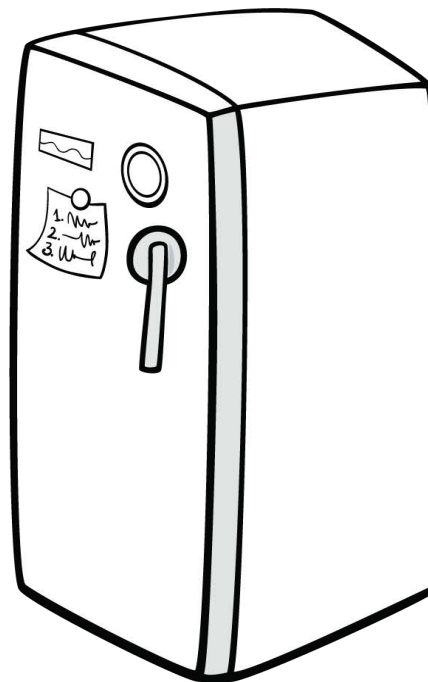

refrigerator

refrigerador

S s

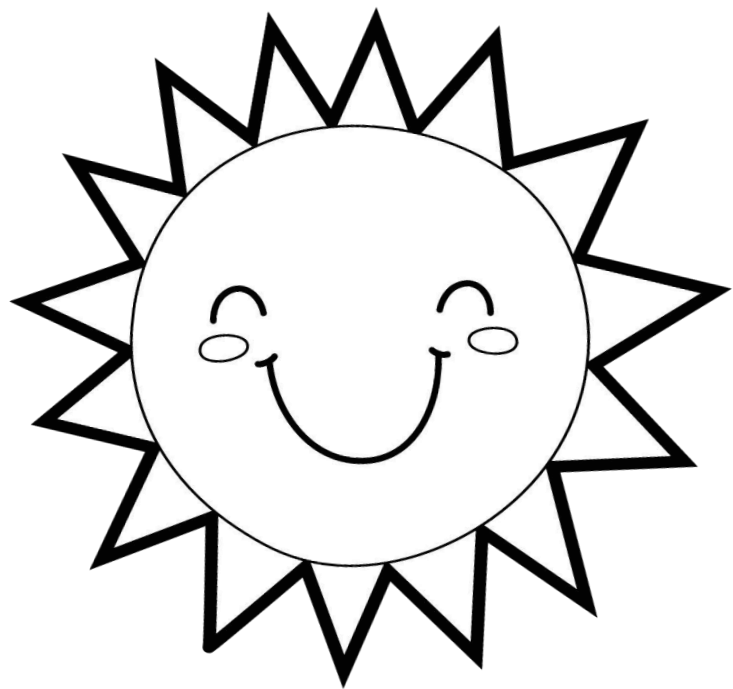

Sun

Sol

S s

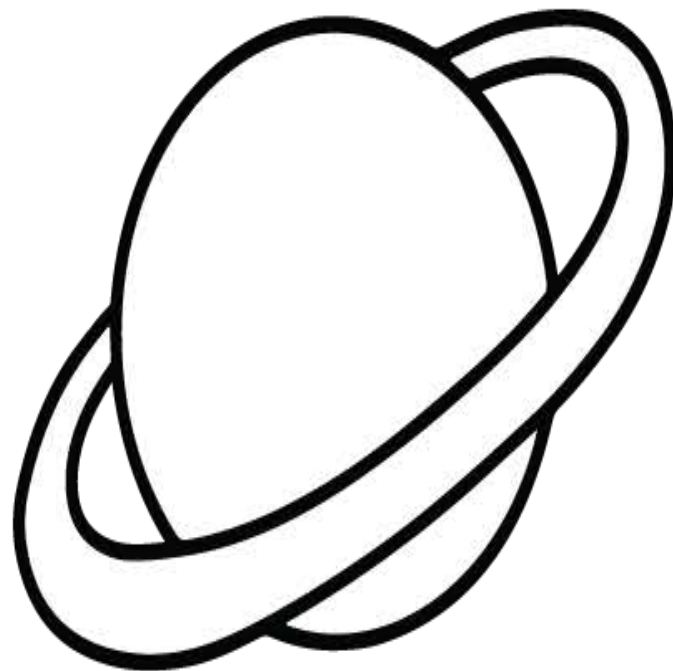

Saturn

Saturno



S s

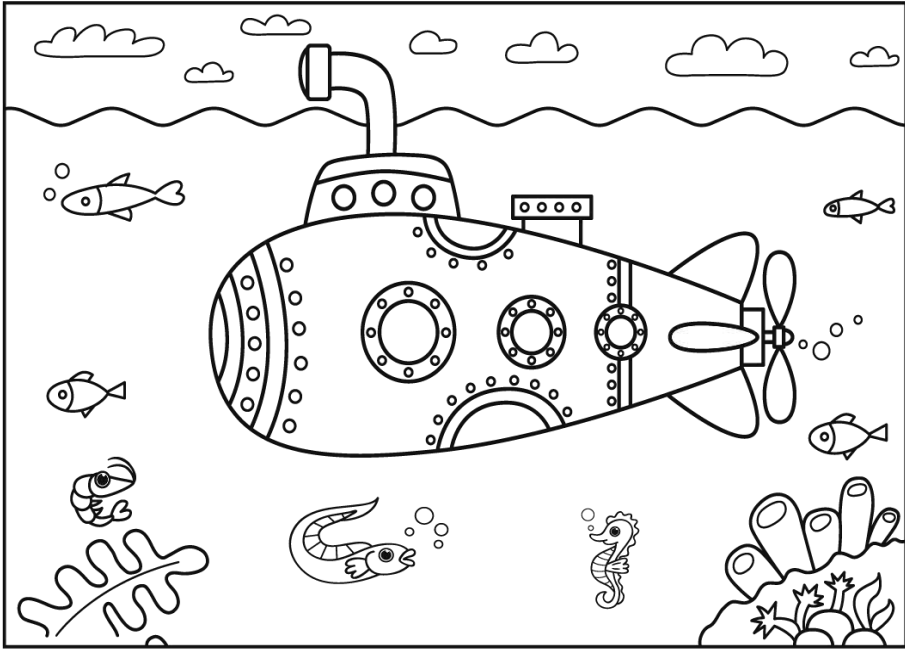

submarine

submarino

S s



salt

sai

五

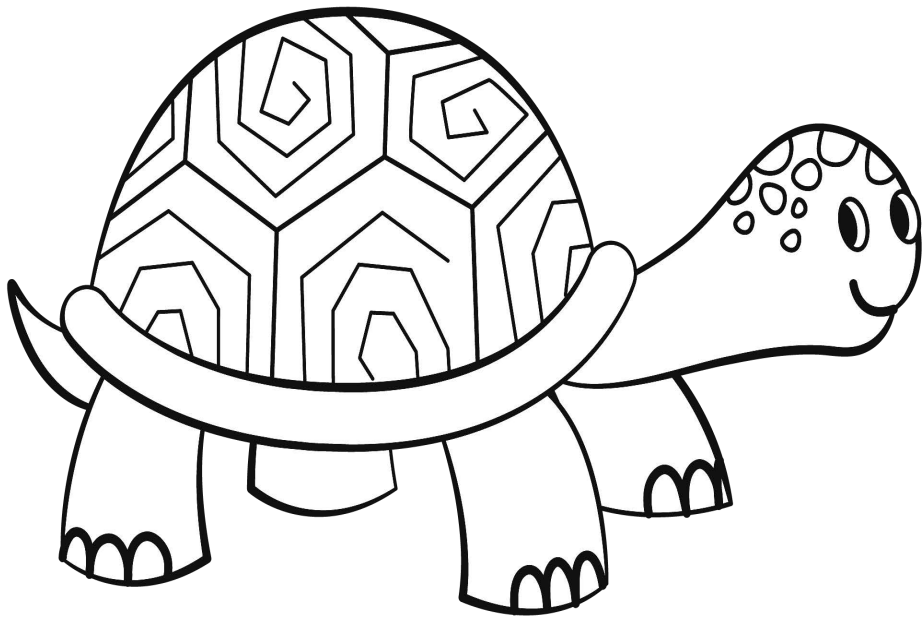

turtle

tortuga

五

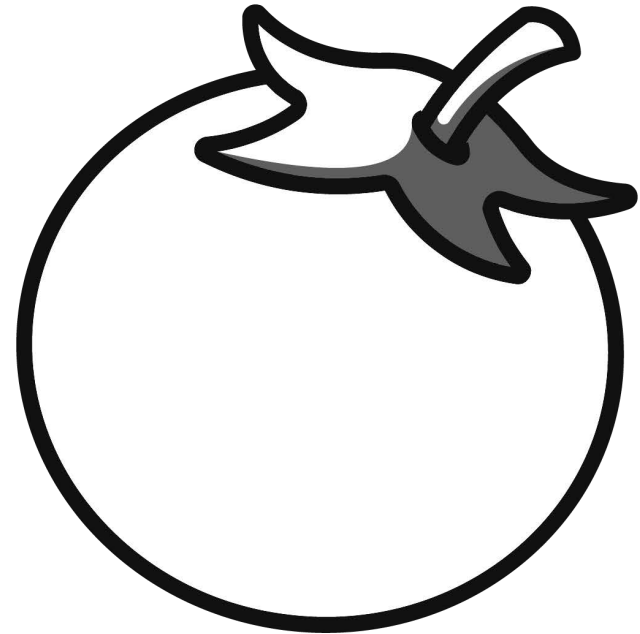

tomato

tomate

五



tiger

tigre

五



toucan

tucón

Uu



unicorn

unicórnio

Uu

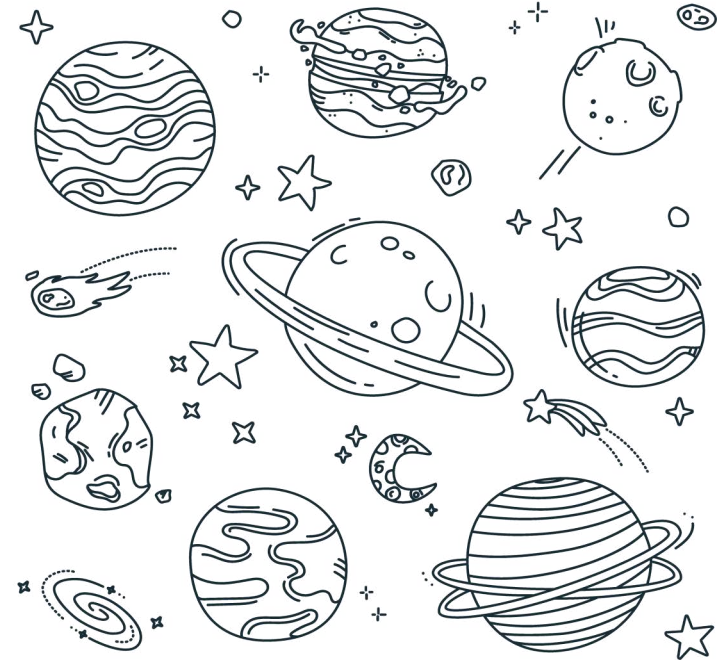

universe

universo

Uu



utensils

utensillos

Uu



uniform

uniforme

Vv



veterinarian

veterinaria

Vv

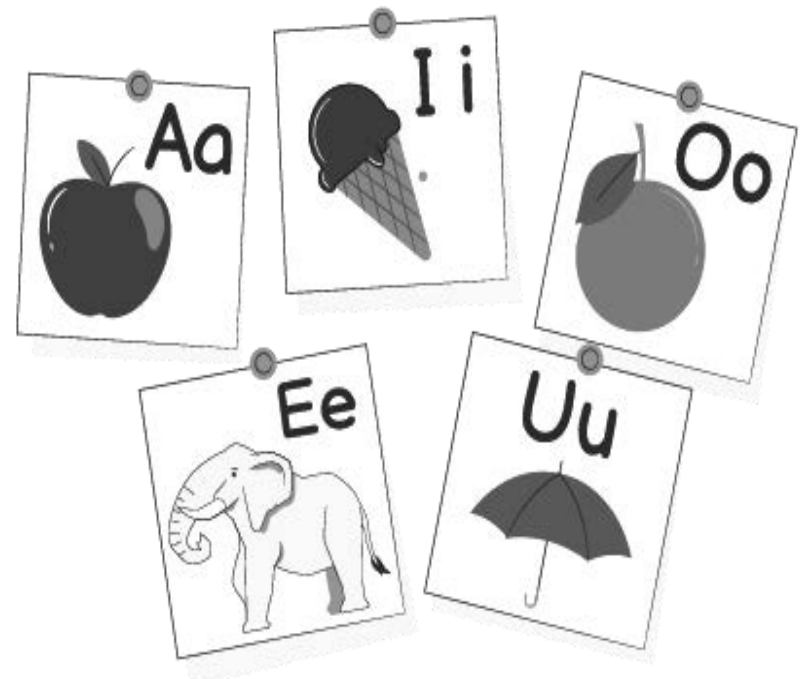

vowels

vocales

Vv

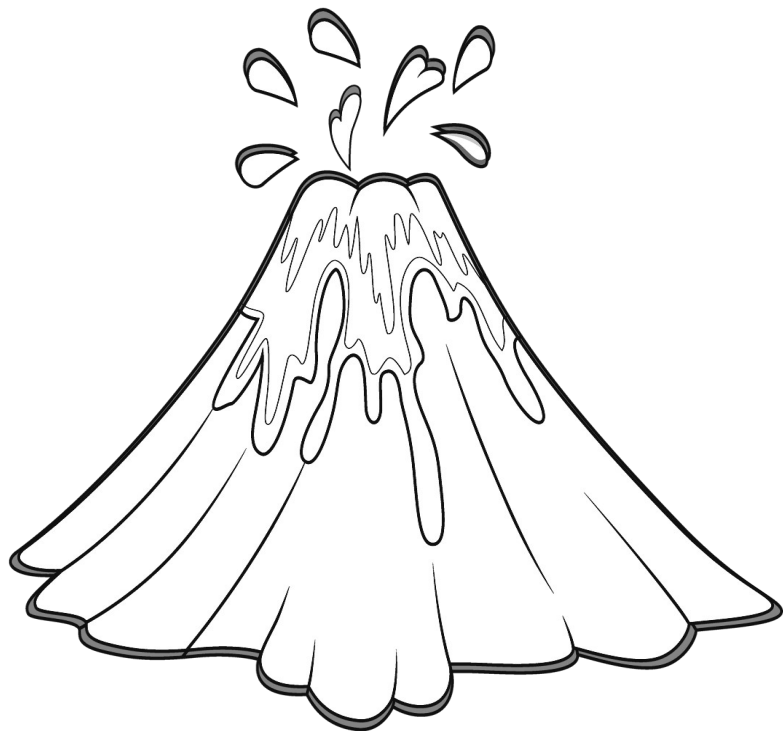

volcáno

volcán

Vv

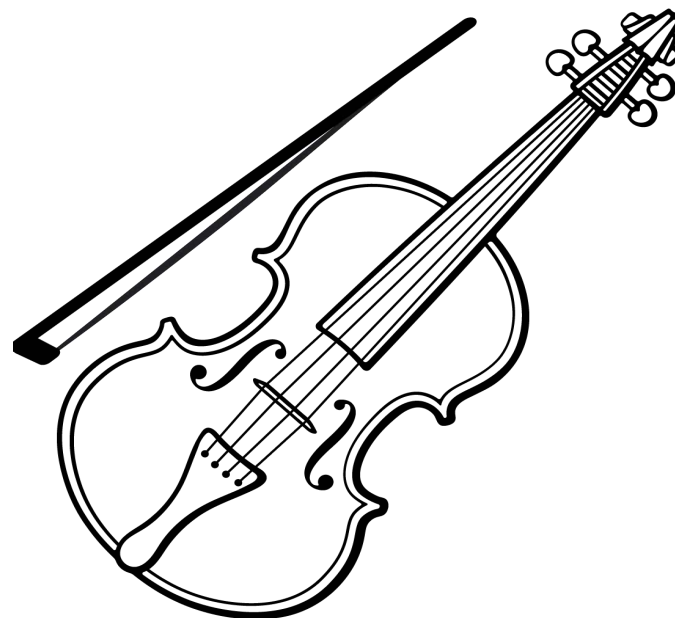

violín

violín

Ww



water polo

waterpolo

Ww



Wi-Fi

wifi



Xx

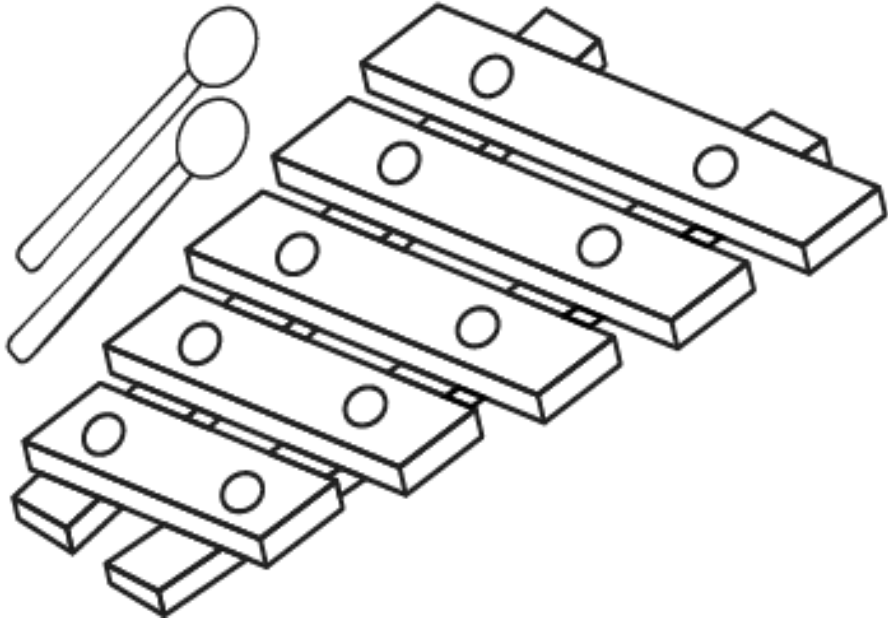

xylophone

xilofono

Xx



X-rays

rayos-X

Yy



yoga

yoga

Yy

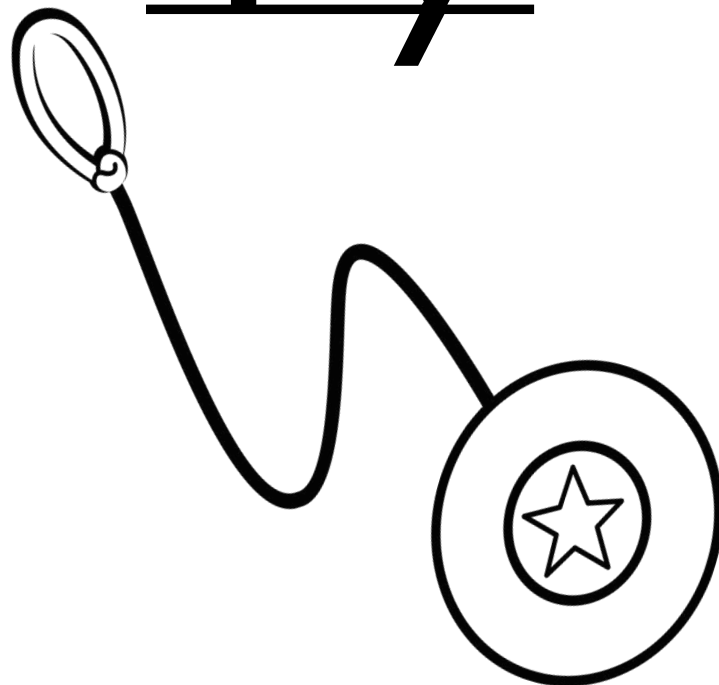

yo-yo

yo-yo

Yy

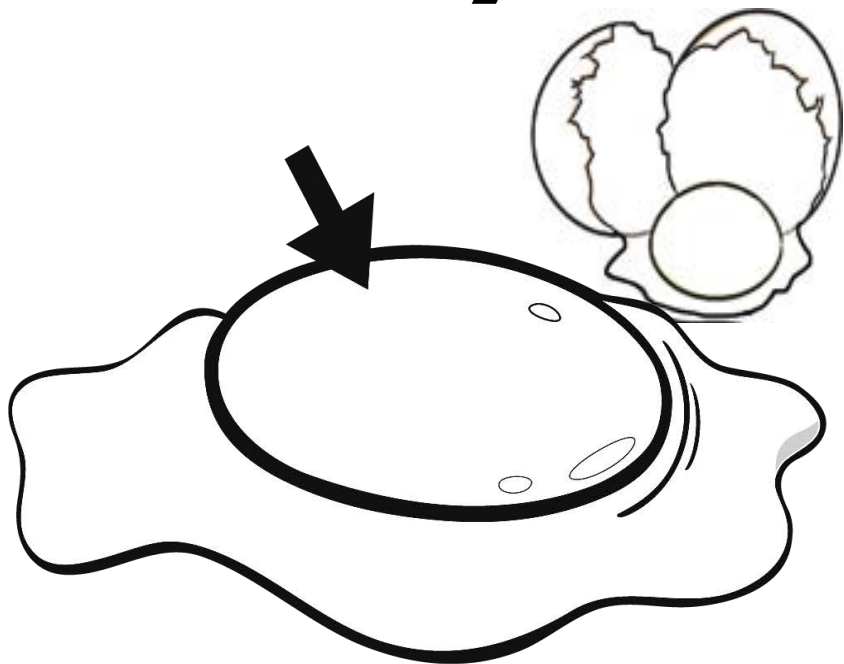

yolk

yema

Yy



yogurt

yogur

Zz



zoo

zoológico

Zz

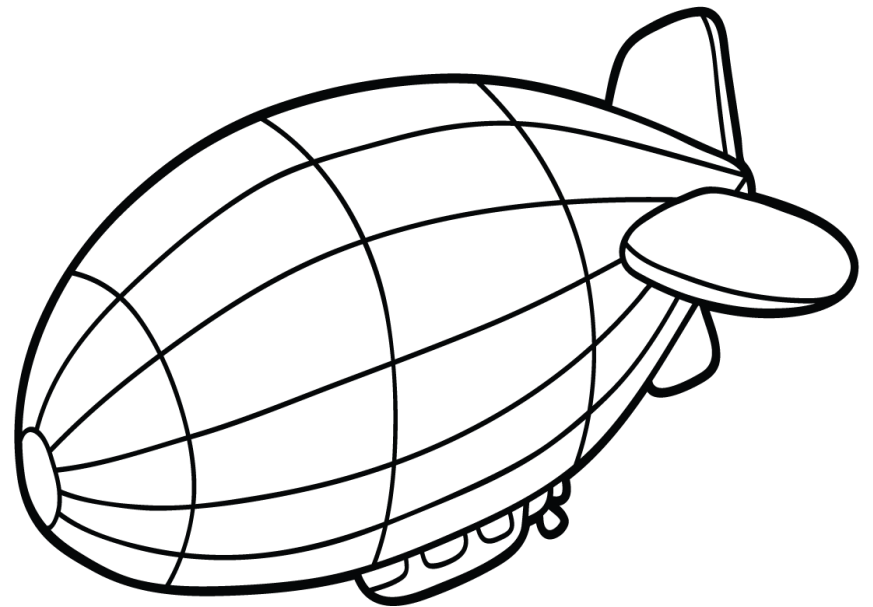

Zeppelin

zepepín

Zz



Zumba

Zumba

Zz



zig-zag

zigzag

## ATTENTION

The Spanish Alphabet has 27 letters.

For teaching and displaying,  
the letter **Ñ ñ** is part of the  
Spanish alphabet.

This letter comes after Nn.

## Ch Ll rr

They remain within the 30 possibilities for  
various **pronunciation**, which make up the  
Spanish phonetic alphabet.

Are included in this set but,

these are NOT part of the alphabet

They are **not** individual letters,  
they are **digraphs** (*two letters that make one sound* ).

<https://www.rae.es/espanol-al-dia/exclusion-de-ch-y-ll-del-abecedario>

## ATENCIÓN

**El abecedario español tiene 27 letras.**

La letra **Ñ ñ** es parte del  
abecedario español.

Para enseñar o exponerla en la pared.  
esta letra viene después de la Nn.

## Ch Ll rr

Se mantienen dentro de las 30 posibilidades  
de **pronunciación** variada, que conforman el  
alfabeto fonético español.

se incluyen en este conjunto pero,  
estas **NO** son parte del alfabeto por  
no ser letras individuales,  
son **dígrafos** (dos letras que hacen un sonido).

<https://www.rae.es/espanol-al-dia/exclusion-de-ch-y-ll-del-abecedario>

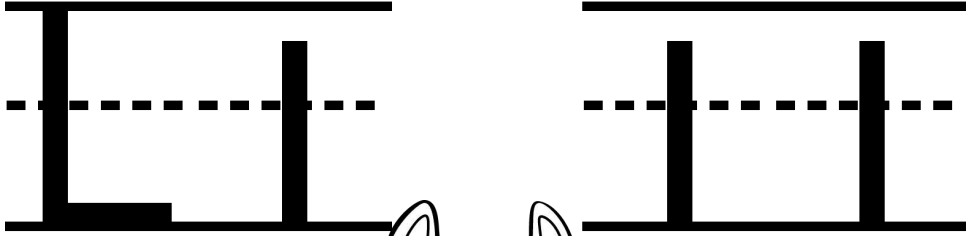

llama

llama

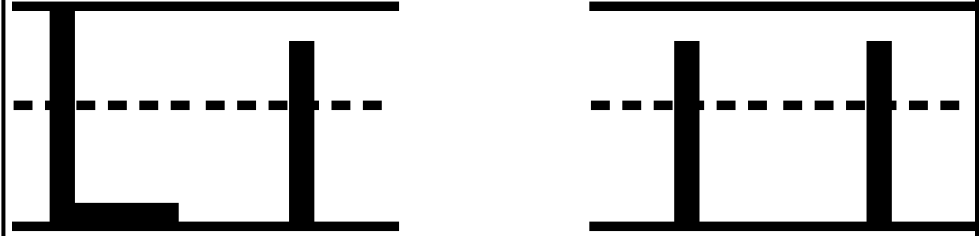

baller

baller

Ch ch

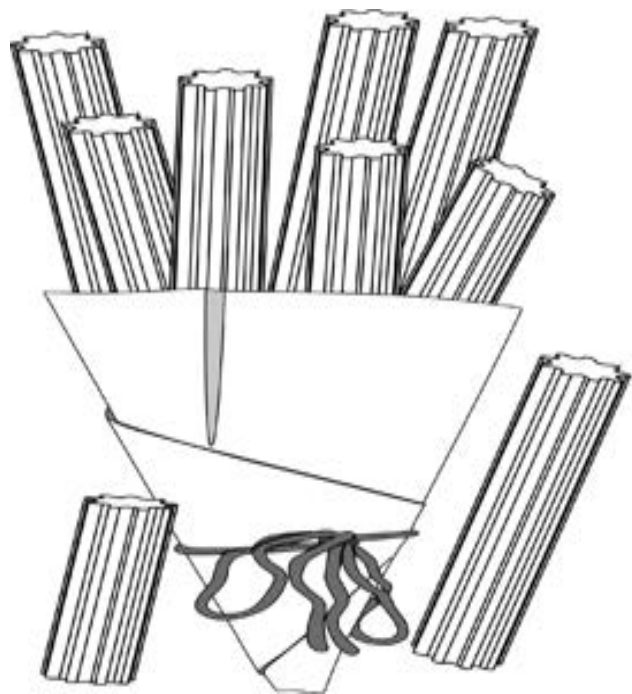

chumos

chumos

rr



barre

barri